



# **EQUITONE** system

## construction details

EQUITONE with concealed fixings

New Zealand

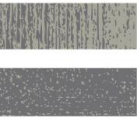

# Table of contents

|  |    |
|--|----|
| General information  | 3  |
| Ventilation  | 4  |
| Components   | 5  |
| EQUITONE concealed fixing system with flexible air barrier | 10 |
| EQUITONE concealed fixing system with rigid air barrier    | 26 |



# General information

This document provides generic construction details for EQUITONE façade systems with concealed fixings to assist with the design of EQUITONE façade.

This document is not designed to serve as an installation guide, and is intended to be used in conjunction with 'EQUITONE Design and Installation Guide\_concealed fixing system' and other relevant technical and installation documents.

Construction details in this document have been independently certified for the purpose of compliance with Clause E2, External moisture, of the New Zealand Building Code within the scope of E2/VM1 and E2/VM2 for EQUITONE façade systems with the recommended pliable and rigid weather barrier, respectively, as described in the 'General components'.

The weatherproofing performance of any project specific detail or application that is different from or not included in the construction details of this document shall be evaluated by the project engineer or consultant.

Cladding support frame and its connection to substructure shall be designed by the project engineer in accordance with the relevant standards. The support frame maximum deflection under the influence of load shall be limited to  $\text{Span}/250$ .

The support frame, fixings, flashings and the like shall be of adequate corrosion resistance appropriate to the corrosivity category of the project location.

Flashings and capping shall be designed with respect to project wind loading, relevant standards and regulations.

Construction details contained in this document are not to a specific scale, and are for illustration purposes only.

The information in this guide is comprehensive but not exhaustive, and the reader will need to satisfy themselves that the contents of this guide are suitable for their intended application. It is the responsibility of the project consultants (designer, architect, and engineers) to ensure that the information and details provided in this document are appropriate for the project.

The information in this document is correct at the time of issuing. However, due to our committed program of continuous material and system development we reserve the right to amend or alter the information contained therein without prior notice. Please contact your local EQUITONE sales organisation to ensure you have the most current version.

This document is supplied in good faith and no liability can be accepted for any loss or damage resulting from its use. All the content of this document is © Copyright of Etex Group. All rights reserved.

This document is protected by International copyright laws. Reproduction and distribution in whole or in part without prior written permission is strictly prohibited. Cedral and logos are trademarks of Etex NV or an affiliate thereof. Any use without authorisation is strictly prohibited and may violate trademark laws.

# Ventilation

A ventilated façade is a kind of two stage construction, an inner structure with a protective outer skin, and the cladding panel or rainscreen. A ventilated façade consists of an insulated and weathertight structure, a ventilated cavity formed with a cladding support frame and the cladding panel.

Allowance for adequate ventilation is paramount in ensuring a successful EQUITONE façade. Ventilated façades provide a number of added benefits to the building and its occupants. These may include but are not limited to the following:

- Positive contribution to energy savings
- Assists with condensation management
- Minimises thermal bridges by providing an opportunity for applying external insulation
- Reduces thermal movement of the structure and cladding support frame
- Dissipates radiant heat
- Increases acoustic performance of the external wall
- Provides an effective drainage path for any moisture passing the cladding skin
- Eliminates the need for exposed caulking and sealant, therefore reducing maintenance requirements
- Assists with keeping the weather barrier dry and healthy
- Provides opportunities for concealing external services such as downpipes within the cavity
- Proven to be a more sustainable and healthier façade construction
- Architectural design flexibility

Air must be allowed to enter the cavity from bottom of the façade, window head, soffit, slab junctions, and the like, and exit from top of the façade, capping, window sill, slab and soffit interfaces, and the like.

All air inlets and outlets are protected against entry of birds and vermin into the cavity with a corrosion resistant perforated profile (angle).

The perforated angle should be less than 0.9mm in thickness where placed between EQUITONE and the support frame, and should have a minimum 50% open area with aperture size of maximum 3mm to 5mm. The perforations must be kept open and unobstructed to maintain drainage and ventilation of the cavity. The perforated angle shall be positioned to allow an adequate drip edge to the cladding panel.

For further information, refer to Design and Installation Guides. Air inlet and outlet sizes shown in this document are indicative only. Refer to the Design and Installation Guide for information about air inlet and outlet sizes which may vary depending on the application and vertical distance between them.

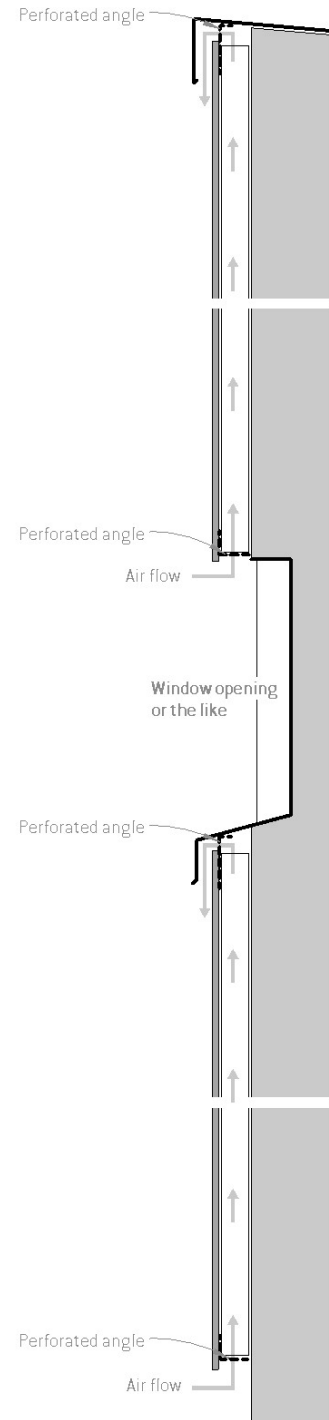

# Components

## Materials

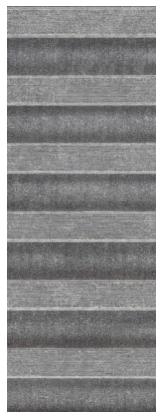

EQUITONE [lines]



EQUITONE [lunara]



EQUITONE [tectiva]



EQUITONE [natura]



EQUITONE [pictura]



EQUITONE [inspira]

### The Minerals

### The Colourfuls

### The Graphicals

### Maximum available panel sizes

EQUITONE [tectiva] 8 mm thick  
EQUITONE [lines] 10 mm thick  
EQUITONE [lunara] 10 mm thick



EQUITONE [natura] 8 and 12 mm thick  
EQUITONE [natura] PRO 8 and 12 mm thick  
EQUITONE [pictura] 8 and 12 mm thick  
EQUITONE [inspira] 8 mm thick

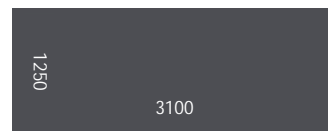
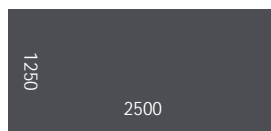

## Panel fixings

### SFS TUF-S

Stainless Steel 316 (A4) grade concealed fixings

#### Notes

The application of the SFS TUF-S fixings shall be in strict accordance with SFS guidelines and recommendations.  
SFS TUF-S is available in various sizes suiting different panel thicknesses.  
SFS TUF-S panel edge distance: 50 – 100 mm

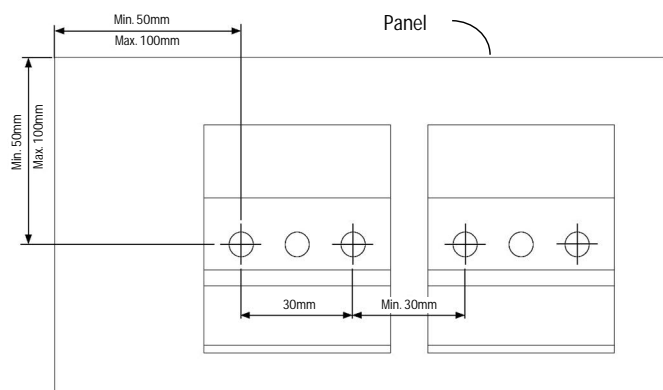

# Components

## Compressible EPDM gasket Tesa®

A compressible closed-cell EPDM gasket used for sealing interfaces with flashings and the like.

12mm Tesa® 66703, 12mm Tesa® 61102, or 12mm PVC Tesa® 60106 where a narrow strip is required as specified on the construction details

40-48mm Tesa® 66703 where located on vertical joints as specified on the construction details



## Expanding foam gasket pro clima CONTEGA® FIDEN EXO

A pre-compressed sealing tape used to seal interfaces with window joineries and the like as specified on the construction details.

The required tape size depends on the gap which needs to be sealed. Refer to pro clima CONTEGA® FIDEN EXO datasheet to determine the required tape size.



## NV3 horizontal express joint backing trim (baffle)

Black coated aluminium baffle is used to form expressed horizontal joints.

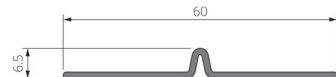

## NV3 vertical express joint backing trim

Black coated aluminium backing trim is used to form expressed vertical joints.

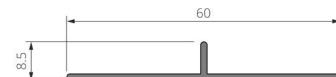

## Weather resistive barrier option 1 Flexible air barrier (pliable membrane)

EQUITONE façade systems have been certified with pro clima SOLITEX EXTASANA® pliable membrane to E2/VM1 for the purpose of compliance with Clause E2 of the NZBC for the following scope:

Serviceability wind pressure: Up to  $\pm 1515\text{Pa}$

Ultimate wind pressure: Up to  $\pm 2500\text{Pa}$

Building height: Up to 10m

pro clima SOLITEX EXTASANA® shall be applied in accordance with pro clima SOLITEX EXTASANA® installation guidelines and relevant standards.



# Components

## Weather resistive barrier option 2 Rigid air barrier

Where a rigid air barrier is required the ADHERO version of pro clima SOLITEX EXTASANA® may be used with minimum 6mm fibre cement sheeting.

EQUITONE façade systems have been certified with pro clima SOLITEX EXTASANA® ADHERO and 6mm fibre cement sheeting to E2/VM2 for the purpose of compliance with Clause E2 of the NZBC for the following scope:

Serviceability wind pressure: Up to  $\pm 2250\text{Pa}$

Building height: Up to 25m

pro clima SOLITEX EXTASANA® ADHERO shall be applied in accordance with pro clima SOLITEX EXTASANA® ADHERO installation guidelines and relevant standards.

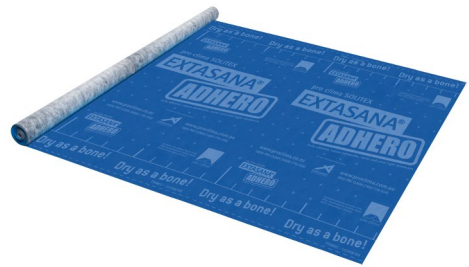

## Flashing tape pro clima TESCON EXTORA®

A pressure sensitive adhesive tape for overlaps and end laps used with both weather resistive barrier options.



## Sill tape pro clima TESCON EXTOSEAL®

A flexible tape for use around window and door openings, used with both weather resistive barrier options.



## Sealing tape pro clima TESCON® NAIDECK mono patch

A single-sided adhesive nail or screw sealing adhesive used with both weather resistive barrier options.



## Foil tape pro clima TESCON® ADHISO WS

A pure aluminium tape for wet seal connections to TESCON EXTOSEAL® and EXTORA® and SOLITEX EXTASANA®.

Note: foil tape is optional and not required when using sealants which are compatible with TESCON EXTOSEAL® and EXTORA® and SOLITEX EXTASANA®. Check with the sealant manufacturer for compatibility with pro clima products.



## Grommet pro clima ROFLEX and KALFEX

pro clima ROFLEX is used to seal pipe and pro clima KALFEX for cable penetrations. pro clima ROFLEX and KALFEX are used with both weather resistive barrier options.



# Support frame

EQUITONE may be fixed to NVELOPE NV3 thermally broken aluminium bracketry framing system.

Support frame shall be of adequate corrosion resistance required for the project.

Structure and support frame shall be designed to relevant standards including, but not limited to, the following:

- AS/NZS 1664.1 – Aluminium structures
- AS/NZS 4600 – Cold-formed steel structures
- NZS 3404 – Steel structures
- NZS 3604 – Timber framed buildings

## Thermal isolator gasket

Used to minimise thermal bridging, and to separate aluminium from steel or concrete.

## Bracket

NVELOPE aluminium brackets are available in two sizes, ie single and double, with various depths to suit a wide range of cavity widths from approx. 50 to 300mm.

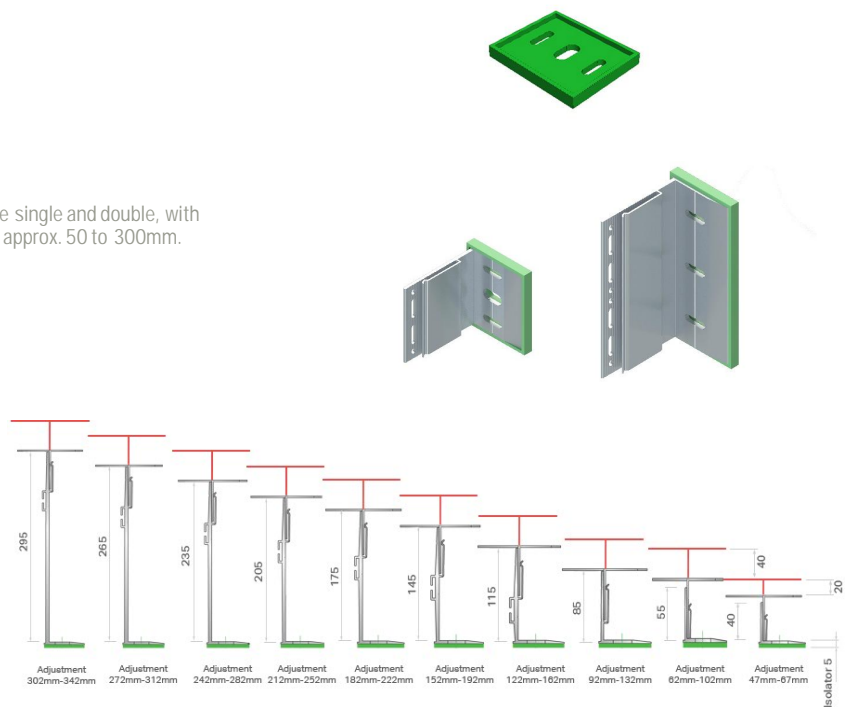

## Vertical rail (profile)

NVELOPE aluminium vertical L rails  
Minimum face width of L rail: 40 mm

## Vertical aluminium Omega (top hat) or Z rail

These may substitute NVELOPE bracket and vertical L rails.





# Support frame

## Horizontal rail

NV3 aluminium horizontal rail onto which EQUITONE panel is mounted.



## Hanger

NV3 aluminium hangers are fixed onto rear of EQUITONE panel with SFS TUF-S concealed fixings. There are two types of hanger – adjustable & static. Adjustable hanger only applies to the top row panel fixings (hangers).

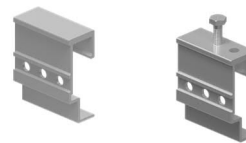

## Isometric view of the assembly



## Notes

Support frame and its connection to substructure shall be designed by project engineer in accordance with the relevant standards. The application of SFS/NVELOPE system shall be in accordance with its supplier's recommendations and guidelines. Refer to SFS/NVELOPE supplier for detailed information on SFS/NVELOPE components and their available sizes and options.

# EQUITONE system

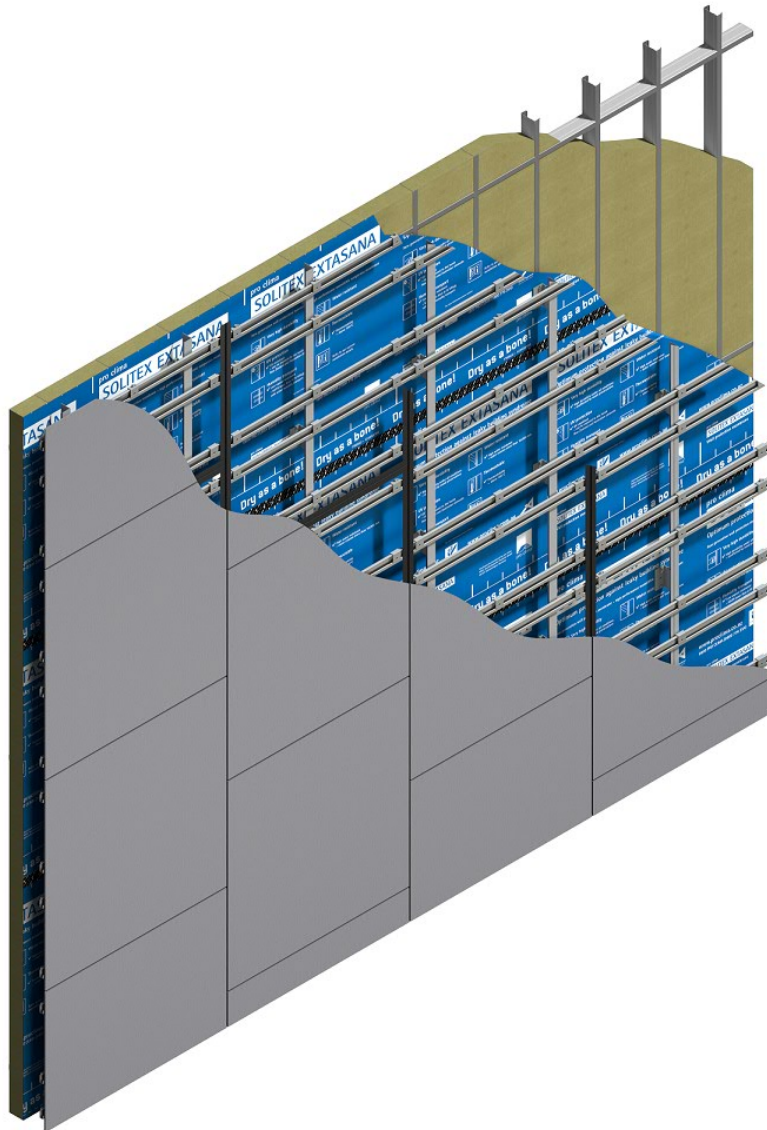

flexible air barrier (pliable membrane)  
concealed fixing system

# Drawings index

| Detail   | Figure | Page |
|--|--------|------|
| Baffled horizontal joint   | 1      | 12   |
| Baffled horizontal joint junction with vertical joint - Elevation  | 2      | 12   |
| Vertical joint - Detail 1  | 3      | 13   |
| Vertical joint - Detail 2  | 4      | 13   |
| Intermediate panel fixings connection                              | 5      | 13   |
| Horizontal control joint   | 6      | 14   |
| Vertical control joint   | 7      | 14   |
| Flush window - Head and sill                                       | 8      | 15   |
| Flush window - Jamb  | 9      | 15   |
| Recessed window - Head and sill                                    | 10     | 16   |
| Recessed window jamb - Option 1                                    | 11     | 16   |
| Recessed window jamb - Option 2                                    | 12     | 16   |
| Meter box - Section  | 13     | 17   |
| Meter box - Plan view - Detail 1                                   | 14     | 17   |
| Meter box - Plan view - Detail 2                                   | 15     | 17   |
| Isometric view of window/meter box opening - Tape application      | 16     | 18   |
| Soffit junction  | 17     | 18   |
| Base detail  | 18     | 19   |
| Base detail - Covered area   | 19     | 19   |
| Base detail - Balcony  | 20     | 19   |
| Junction with other materials - flush detail                       | 21     | 20   |
| Junction with other materials, eaves or the like - recessed detail | 22     | 20   |
| Exposed concrete slab or beam - Cladding flush                     | 23     | 21   |
| Exposed concrete slab or beam - Cladding recessed                  | 24     | 21   |
| External corner  | 25     | 22   |
| Abutment   | 26     | 22   |
| Internal corner  | 27     | 22   |
| Pipe penetration - Plan view                                       | 28     | 23   |
| Pipe penetration - Elevation                                       | 29     | 23   |
| Pipe penetration - Section   | 30     | 23   |
| Capping - Detail 1   | 31     | 24   |
| Capping - Detail 2   | 32     | 24   |
| Parapet junction - Section   | 33     | 24   |
| Parapet junction - Plan view                                       | 34     | 25   |
| Corrosion resistant saddle flashing                                | 35     | 25   |

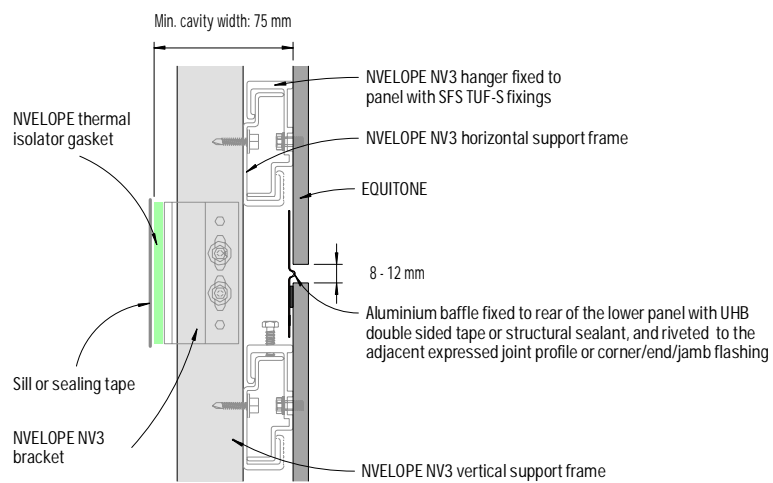

Figure 1: Baffled horizontal joint  
(Not suitable for EQUITONE [material])

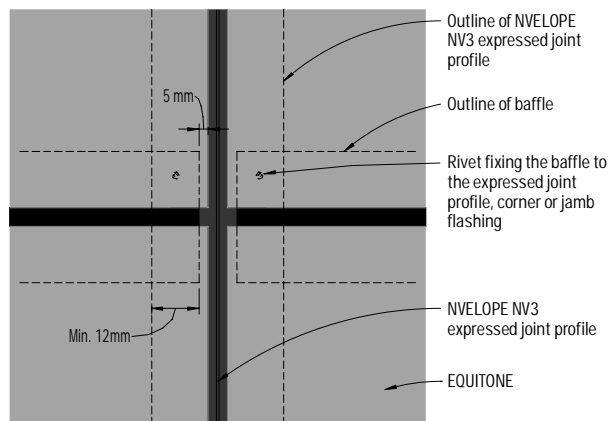

Figure 2: Baffled horizontal joint  
junction with vertical joint - Elevation

Notes

- 1) The length of NVELOPE NV3 vertical and horizontal rail, and expressed joint profile must NOT exceed 3,150mm.

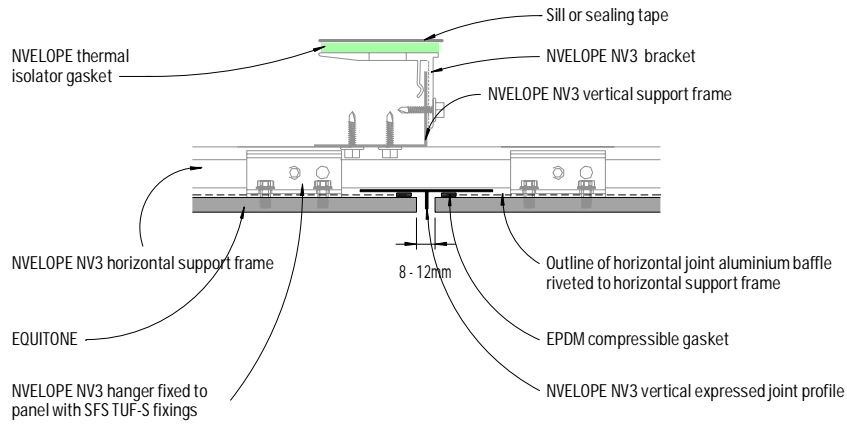

Figure 3: Vertical joint - Detail 1

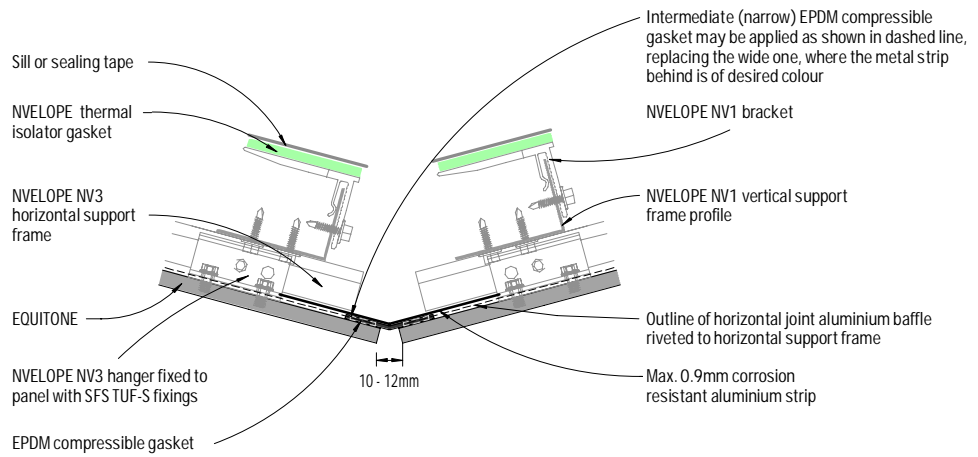

Figure 4: Vertical joint - Detail 2

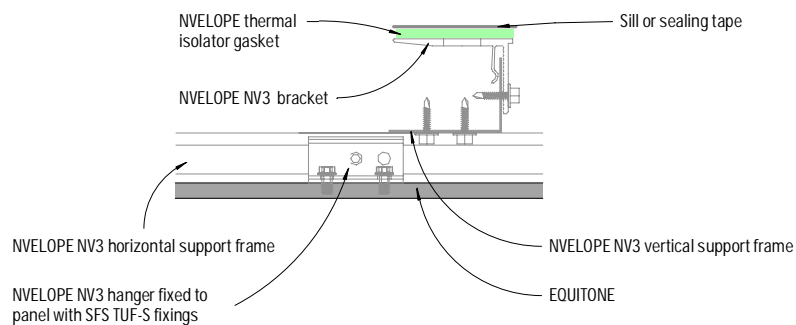

Figure 5: Intermediate panel fixings connection

Notes

- 1) The deflection of NVELOPE NV3 vertical expressed joint profile (as included in Figure 3) and any aluminium strip located at the vertical joint (as included in Figure 4) shall be limited to an extent ensuring the seal along the vertical joint is maintained with respect to project wind loading.
- 2) The aluminium strip should be fixed ONLY to one of the support frame profiles (either left or right) where allowance for horizontal and/or vertical movement of the cladding frame is required.
- 3) For EQUITONE [material] refer to EQUITONE construction details with rigid air barrier.

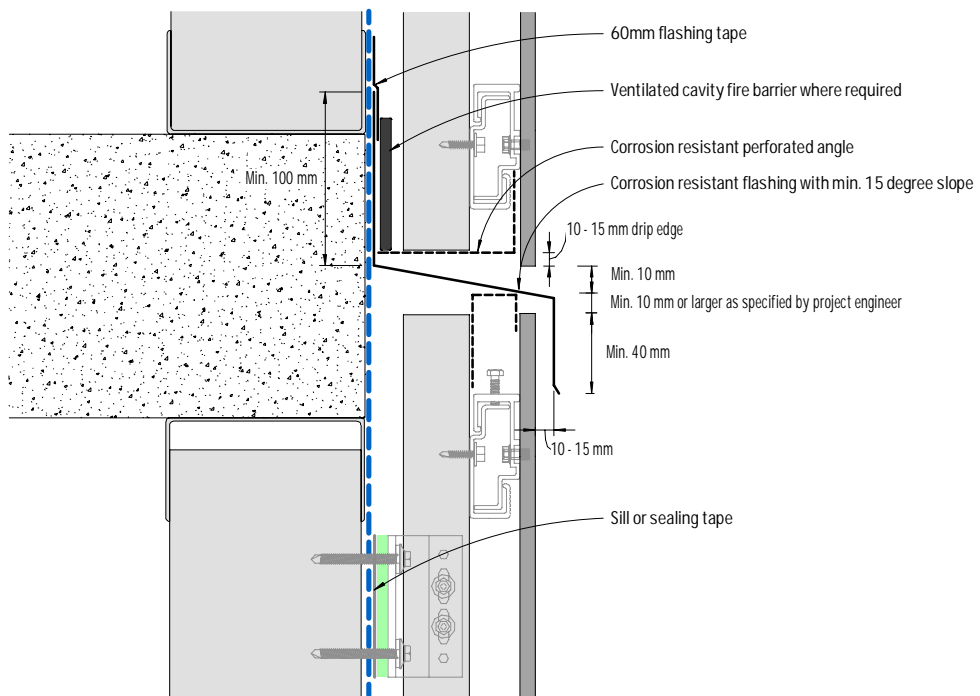

Figure 6: Horizontal control joint

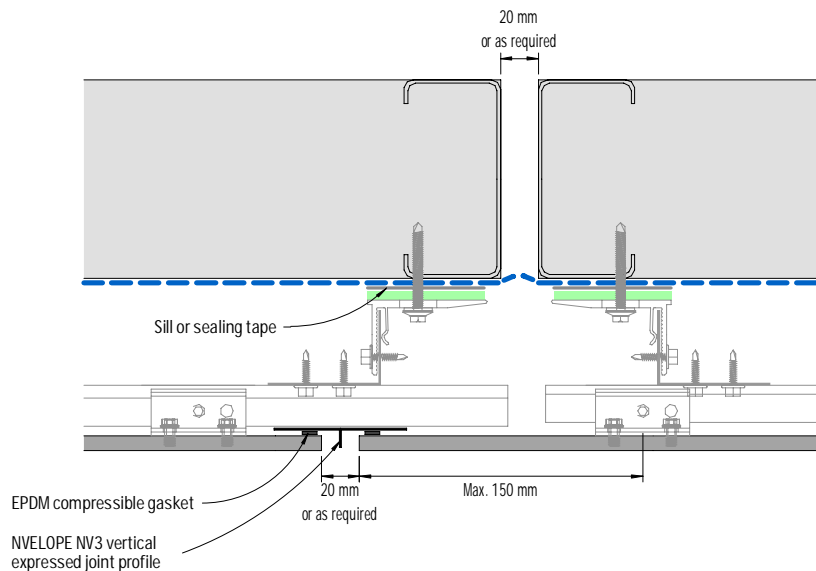

Figure 7: Vertical control joint

#### Notes

- 1) Support frame profiles must NOT be fixed crossing over a control joint.
- 2) The deflection of NVELOPE NV3 vertical expressed joint profile shall be limited to an extent ensuring the seal along the vertical joint is maintained with respect to project wind loading.
- 3) Allowance for movement at the location of any control joint must be made in the cladding and its support frame design and installation. Panel must NOT be fixed bridging over any control joint.
- 4) Corrosion resistant perforated angle shall be of max. thickness of 0.9mm where located between panel and support frame, and be of min. 50% open area with aperture size of 3-5mm.

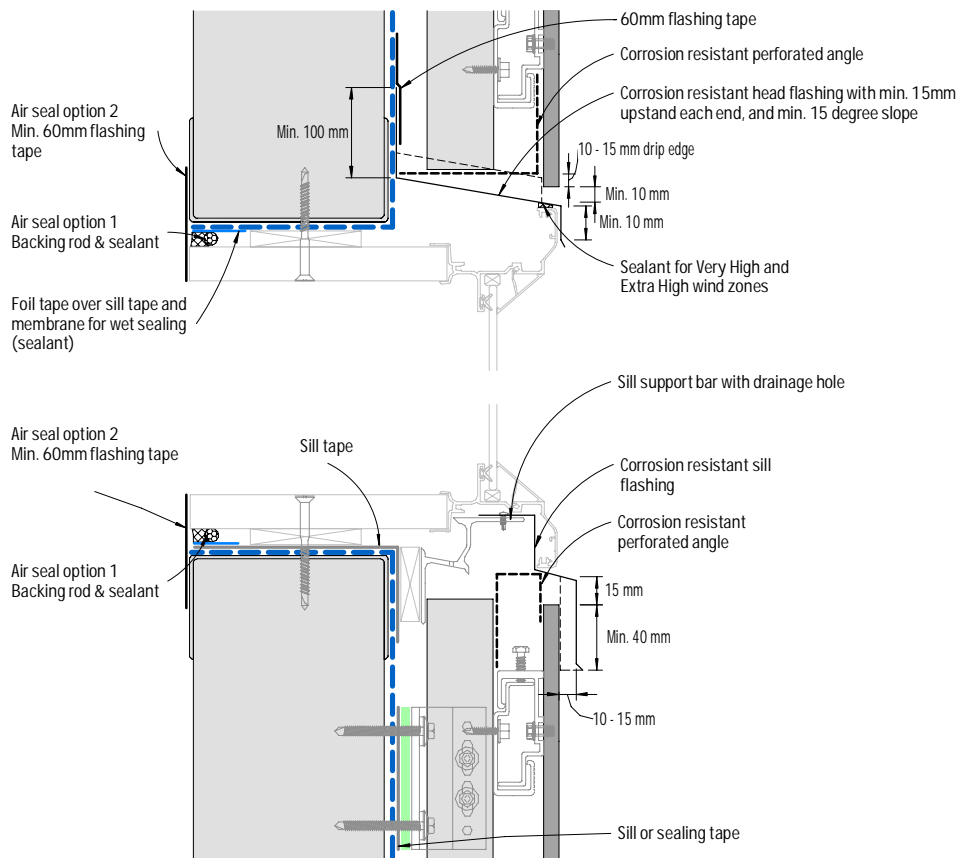

Figure 8: Flush window - Head and sill

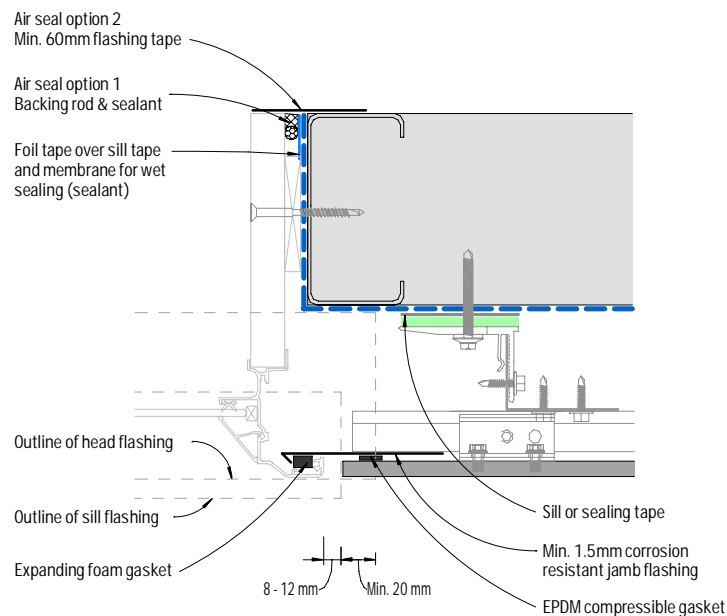

Figure 9: Flush window - Jamb

**Notes**

- 1) ONLY sealant compatible with the foil tape should be used. Should any sealant be intended to be used directly on the flashing and/or sill tape it must be confirmed with its manufacturer to ensure compatibility with these tapes in accordance with the relevant standards.
- 2) Corrosion resistant perforated angle shall be of max. thickness of 0.9mm where located between panel and support frame, and be of min. 50% open area with aperture size of 3-5mm.

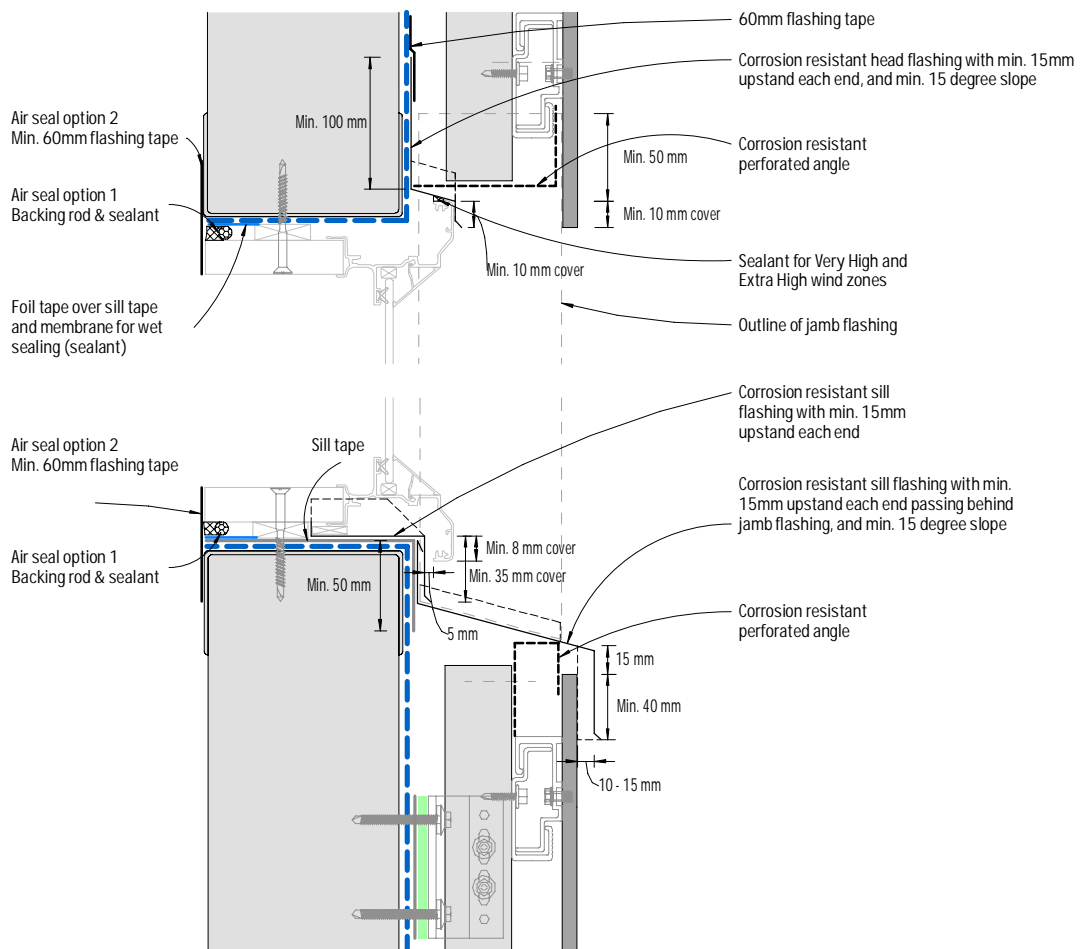

Figure 10: Recessed window - Head and sill

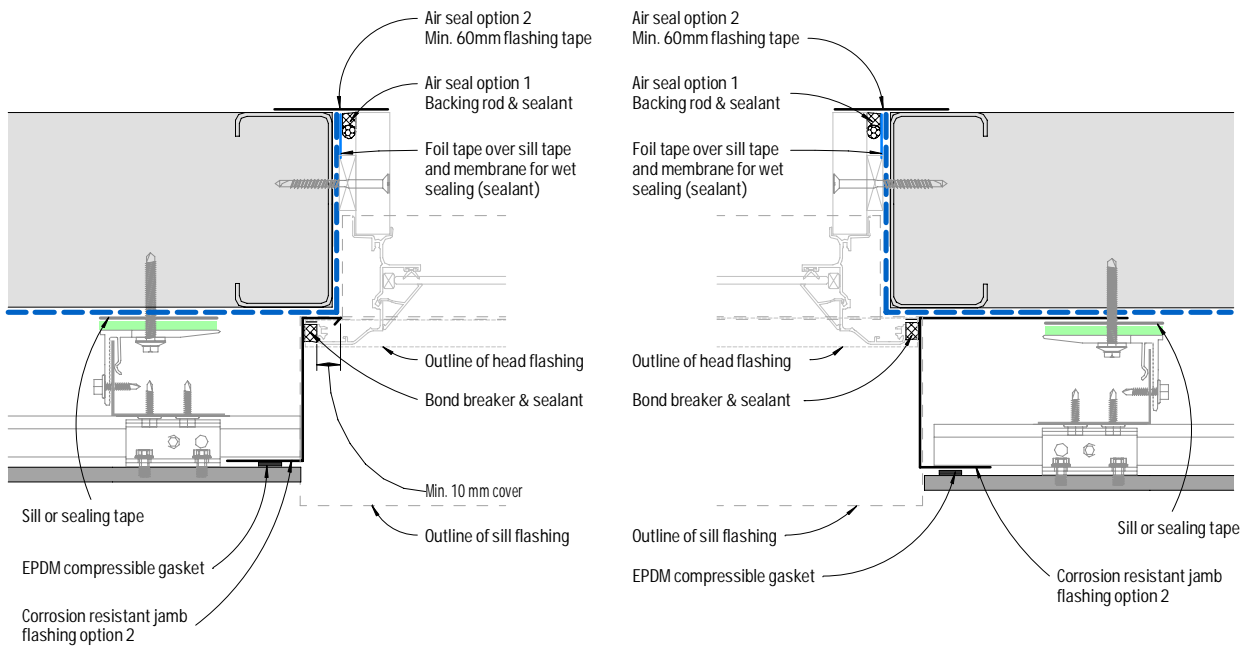

Figure 11: Recessed window jamb - Option 1

Figure 12: Recessed window jamb - Option 2

Notes

- 1) ONLY sealant compatible with the foil tape should be used. Should any sealant be intended to be used directly on the flashing and/or sill tape it must be confirmed with its manufacturer to ensure compatibility with these tapes in accordance with the relevant standards.
- 2) Corrosion resistant perforated angle shall be of max. thickness of 0.9mm where located between panel and support frame, and be of min. 50% open area with aperture size of 3-5mm.



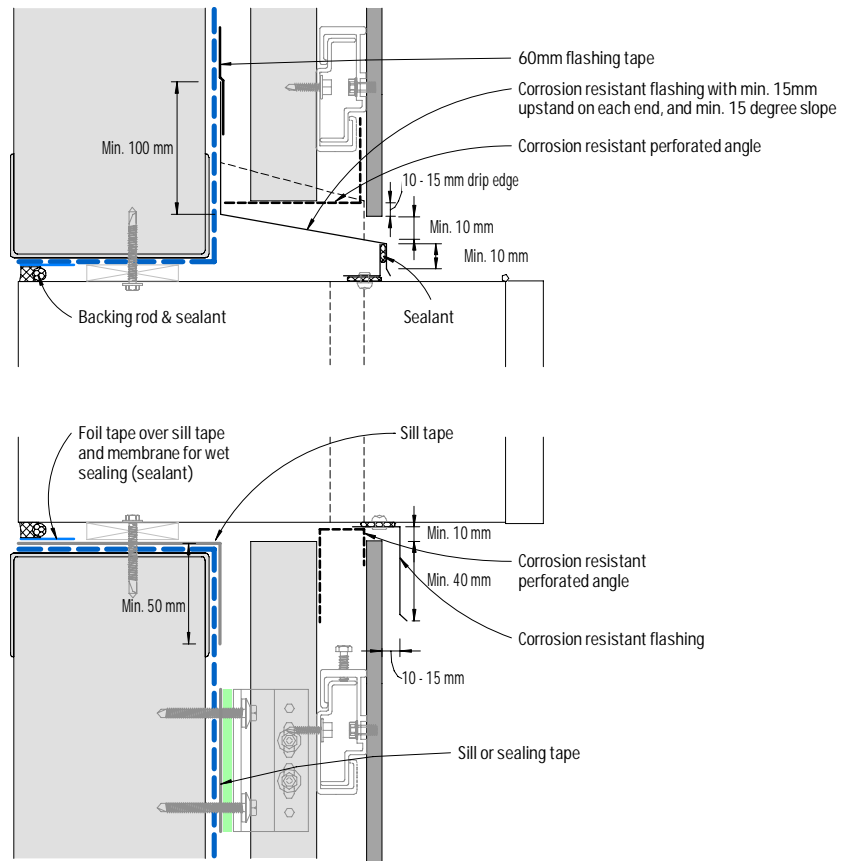

Figure 13: Meter box - Section

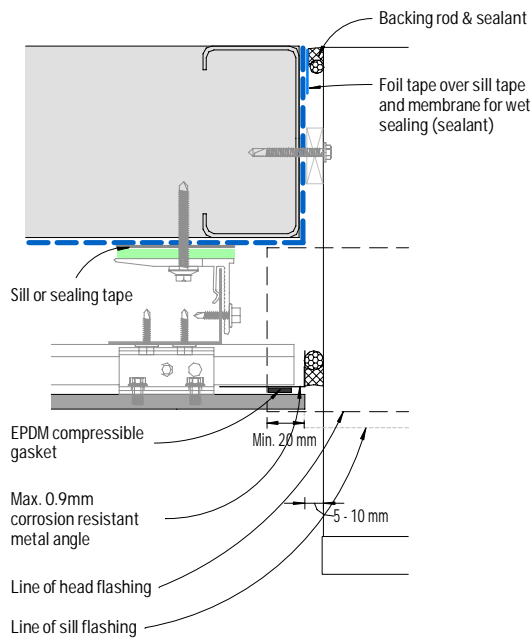

Figure 14: Meter box - Plan view - Detail 1

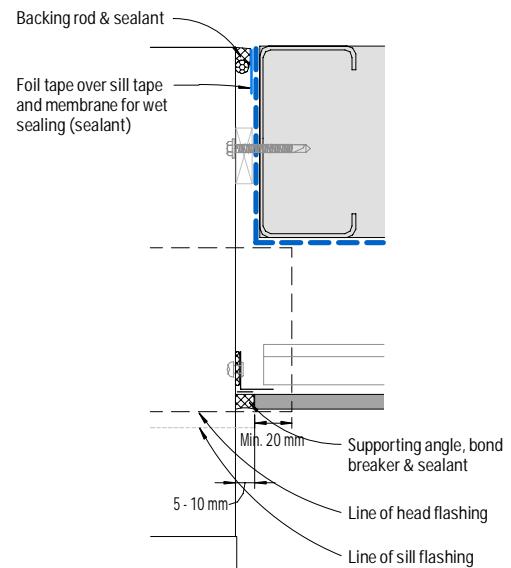

Figure 15: Meter box - Plan view - Detail 2

Notes

- 1) ONLY sealant compatible with the foil tape should be used. Should any sealant be intended to be used directly on the flashing and/or sill tape it must be confirmed with its manufacturer to ensure compatibility with these tapes in accordance with the relevant standards.
- 2) Corrosion resistant perforated angle shall be of max. thickness of 0.9mm where located between panel and support frame, and be of min. 50% open area with aperture size of 3-5mm.

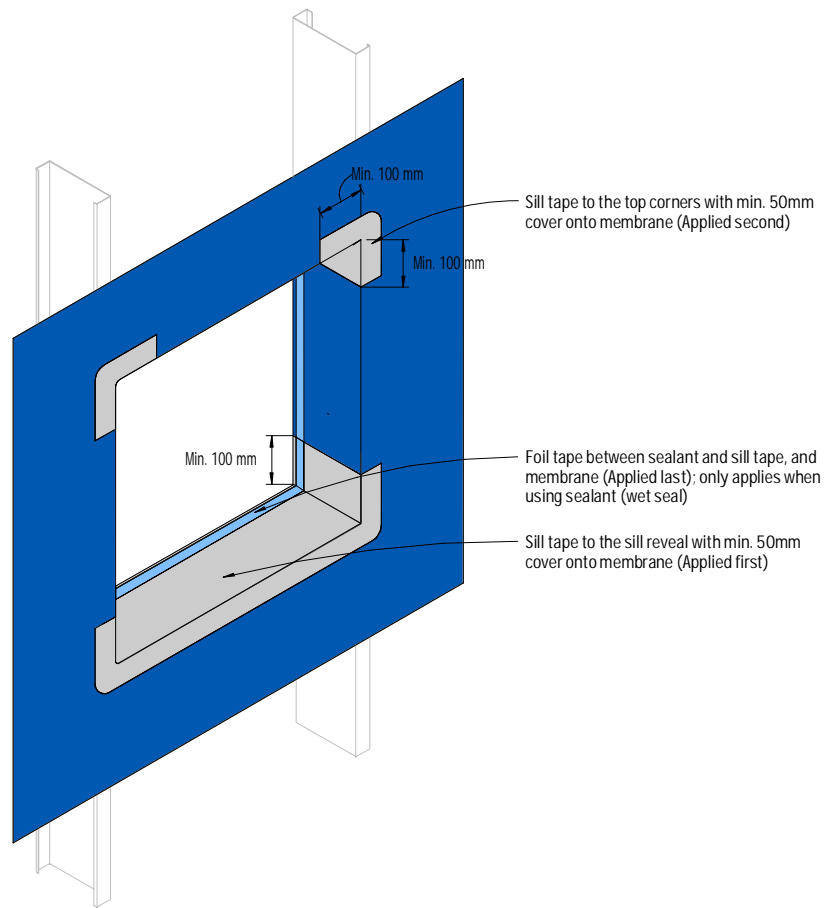

Figure 16: Isometric view of window/meter box opening - Tape application

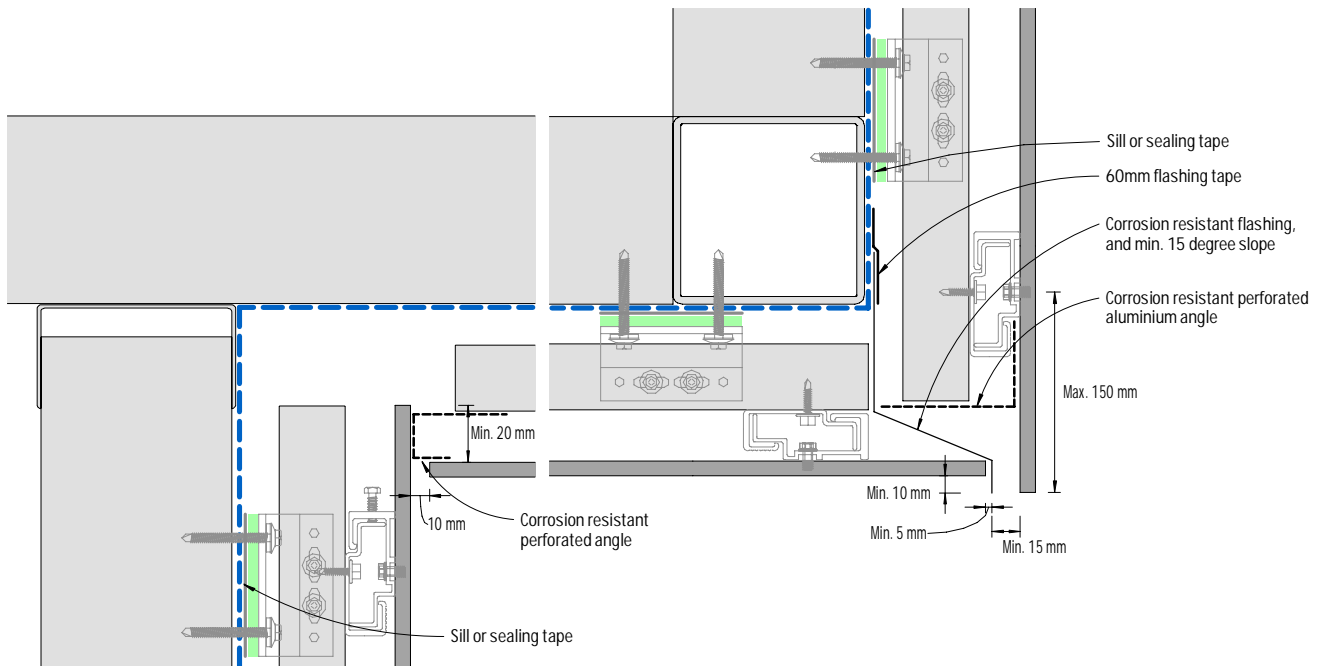

Figure 17: Soffit junction

Notes

- 1) ONLY sealant compatible with the foil tape should be used. Should any sealant be intended to be used directly on the flashing and/or sill tape it must be confirmed with its manufacturer to ensure compatibility with these tapes in accordance with the relevant standards.
- 2) Support frame profiles must NOT be fixed crossing over a control joint.
- 3) Corrosion resistant perforated angle shall be of max. thickness of 0.9mm where located between panel and support frame, and be of min. 50% open area with aperture size of 3-5mm.

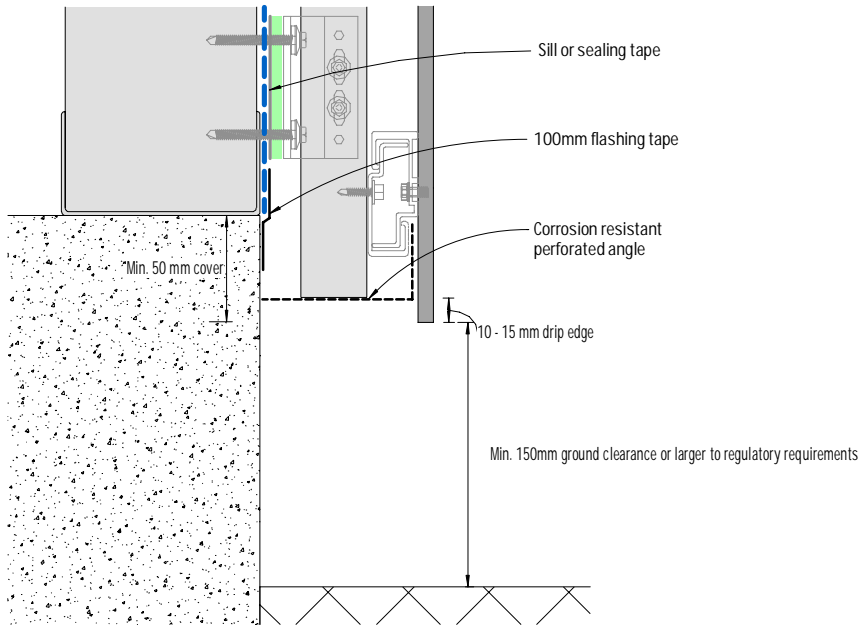

Figure 18: Base detail

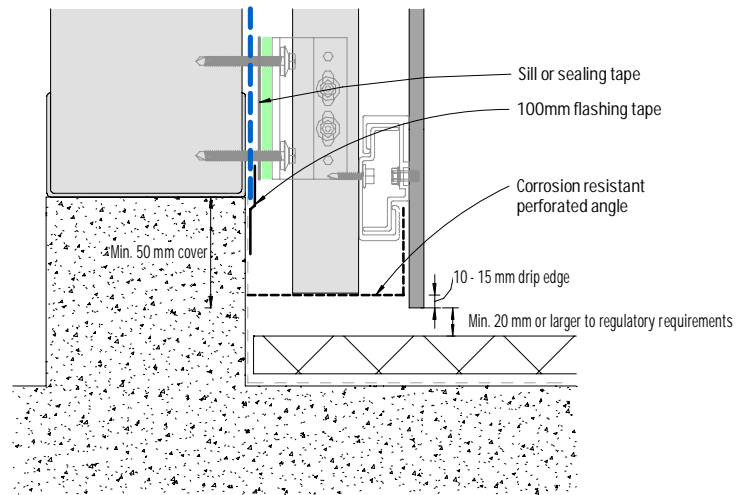

Figure 19: Base detail - Covered area

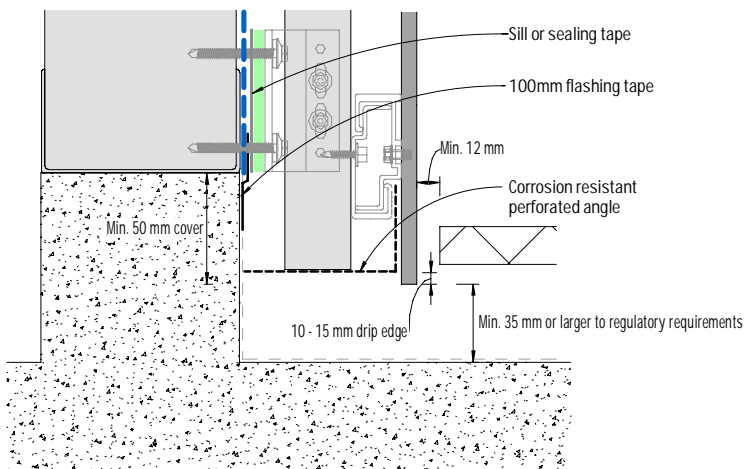

Figure 20: Base detail - Balcony

Notes

- 1) For **EQUITONE [materia]**, minimum ground clearance is **300mm**.
- 2) Corrosion resistant perforated angle shall be of max. thickness of 0.9mm where located between panel and support frame, and be of min. 50% open area with aperture size of 3-5mm.

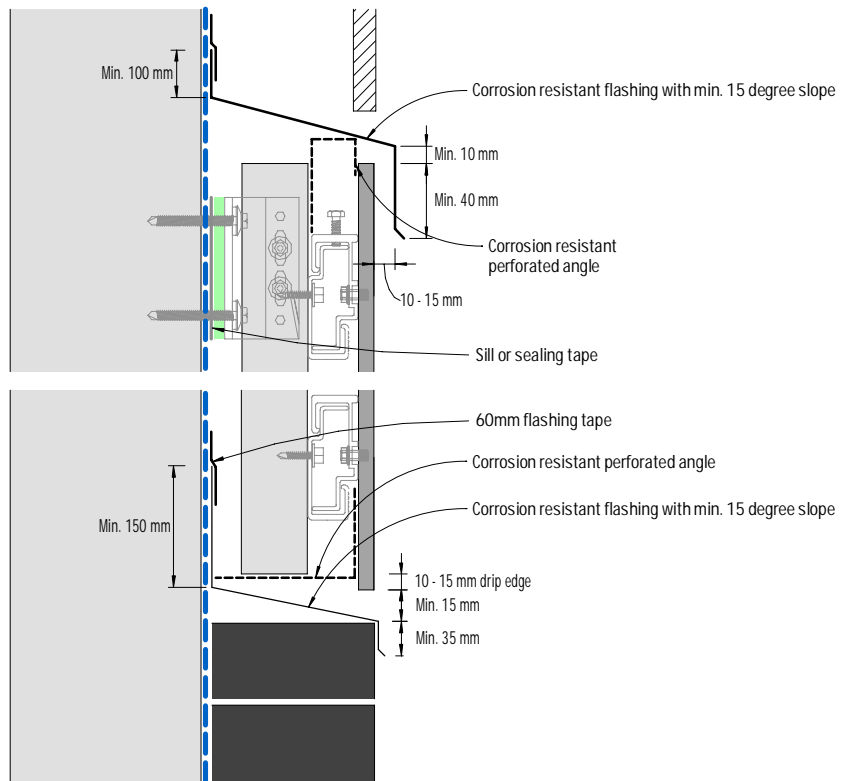

Figure 21: Junction with other materials - flush detail

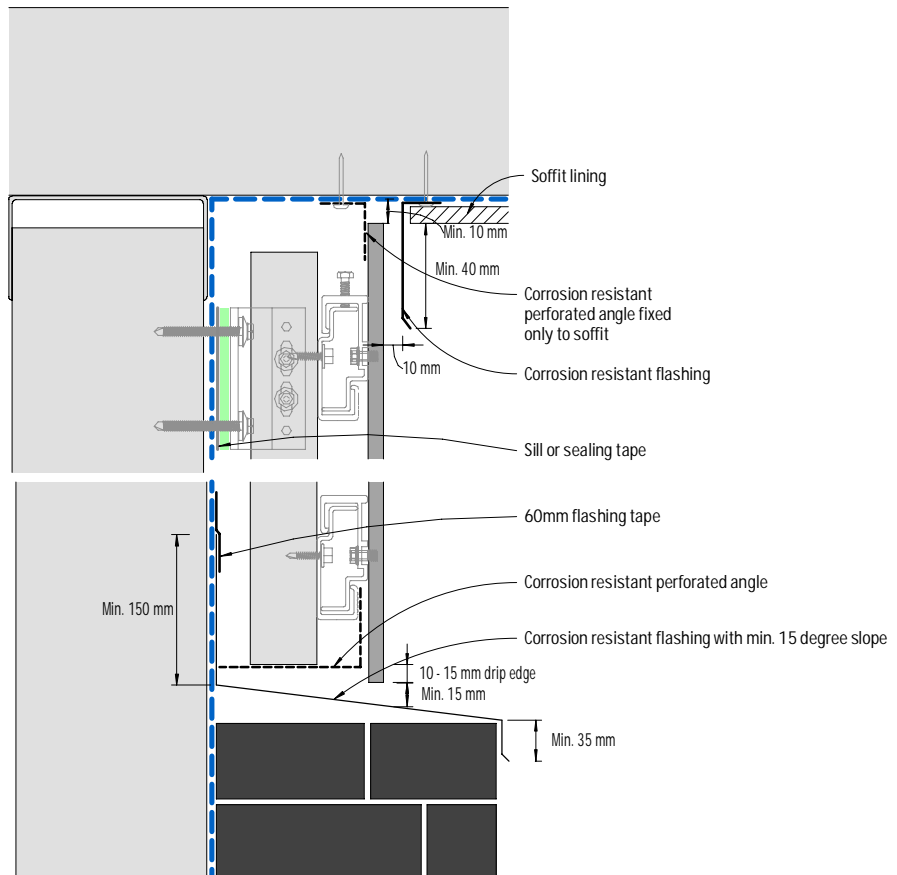

Figure 22: Junction with other materials, eaves or the like - recessed detail

Notes

- 1) Support frame profiles must NOT be fixed crossing over a control joint.
- 2) Corrosion resistant perforated angle shall be of max. thickness of 0.9mm where located between panel and support frame, and be of min. 50% open area with aperture size of 3-5mm.

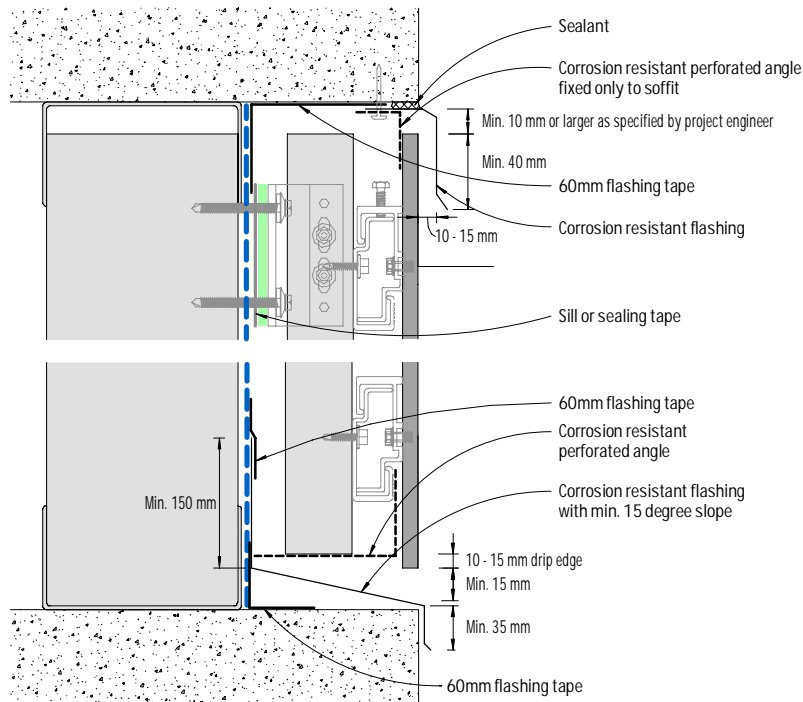

Figure 23: Exposed concrete slab or beam - Cladding flush

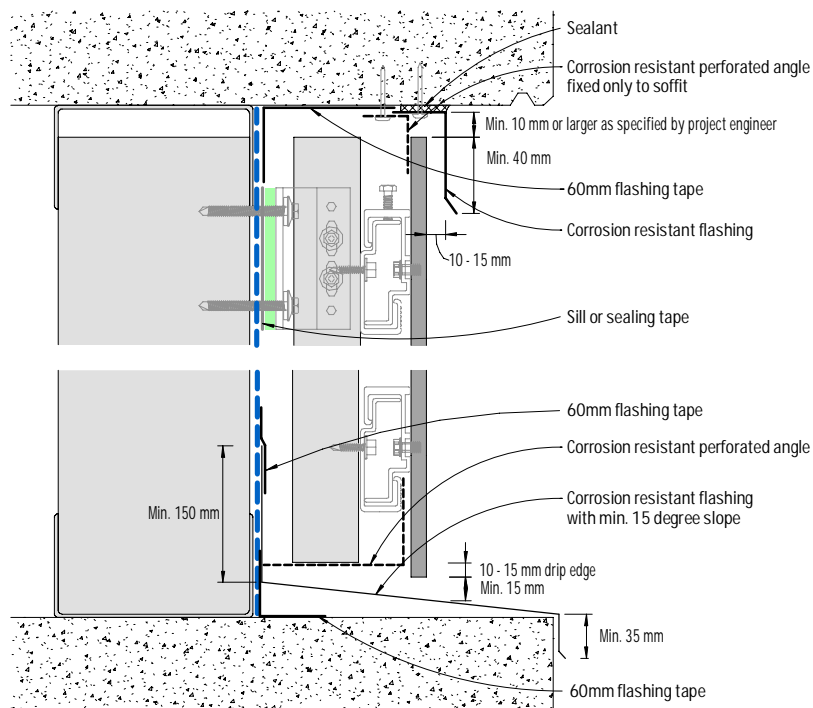

Figure 24: Exposed concrete slab or beam - Cladding recessed

Notes

- 1) Refer to Pro Clima's flashing tape application guide for any pre-treatment required on concrete or masonry for the application of the flashing tape onto these substrates.
- 2) Support frame profiles must NOT be fixed crossing over a control joint.
- 3) Corrosion resistant perforated angle shall be of max. thickness of 0.9mm where located between panel and support frame, and be of min. 50% open area with aperture size of 3-5mm.

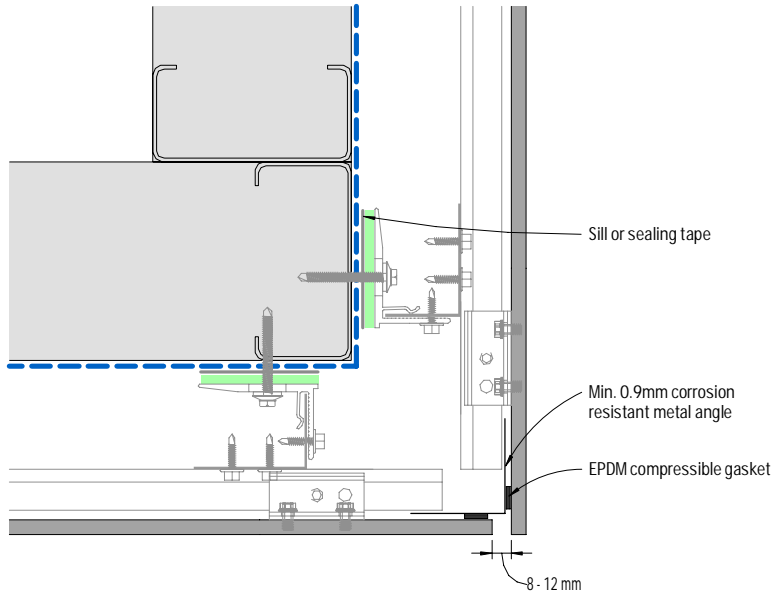

Figure 25: External corner

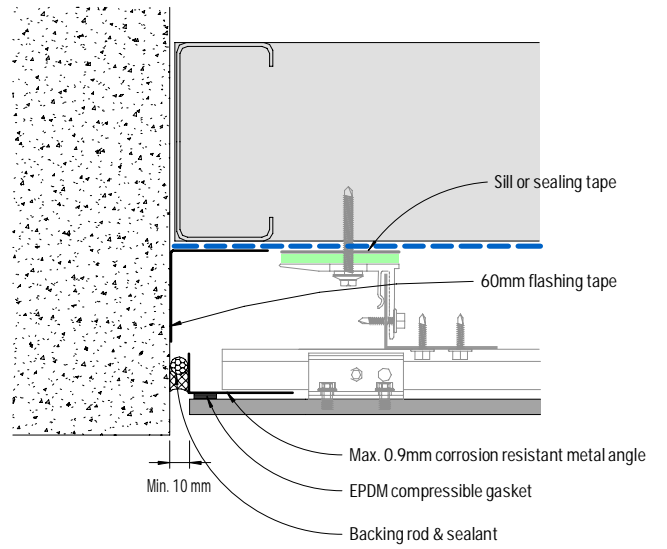

Figure 26: Abutment

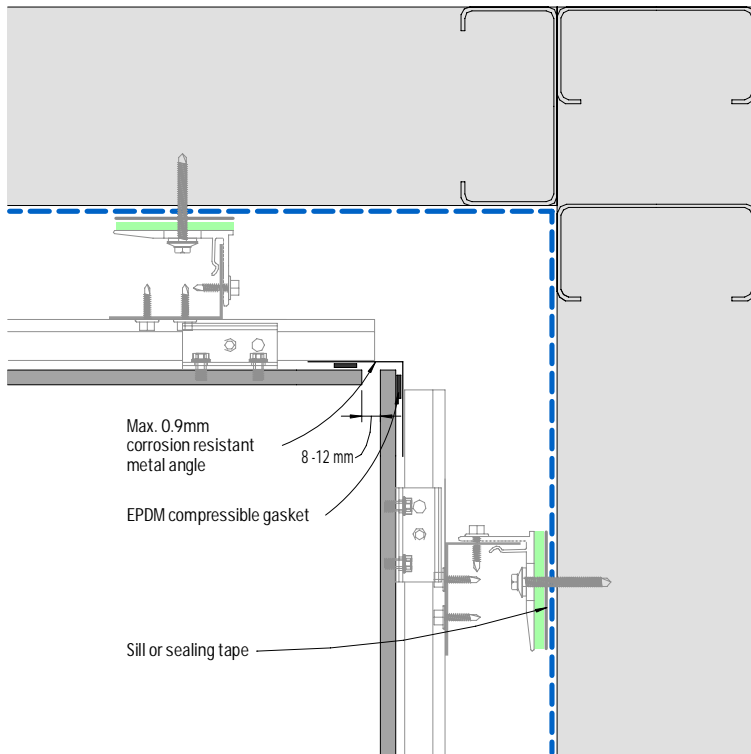

Figure 27: Internal corner

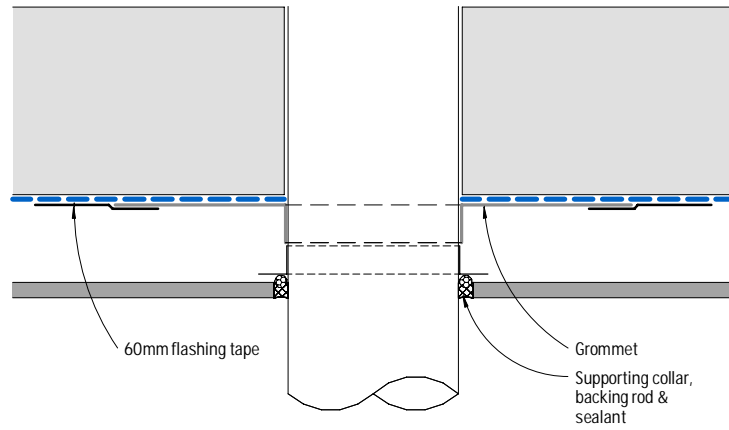

Figure 28: Pipe penetration - Plan view

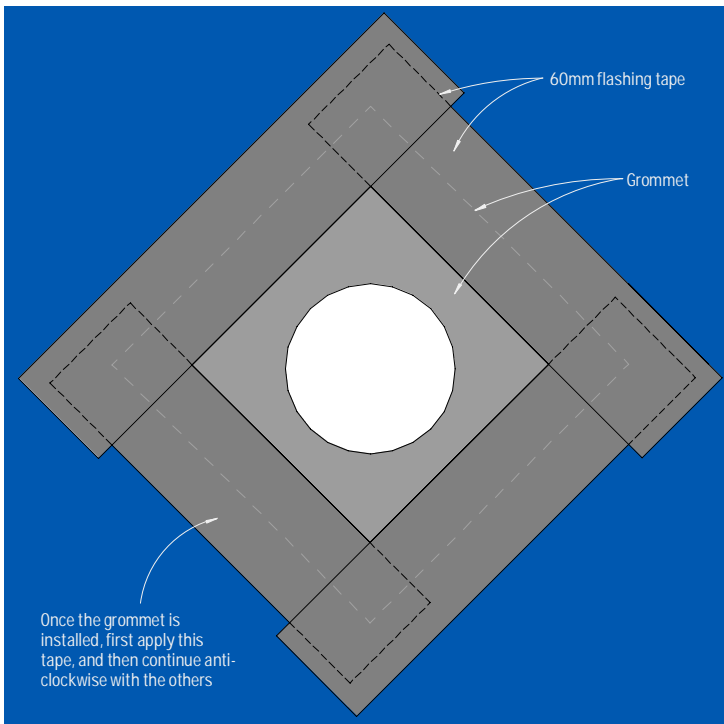

Figure 29: Pipe penetration - Elevation

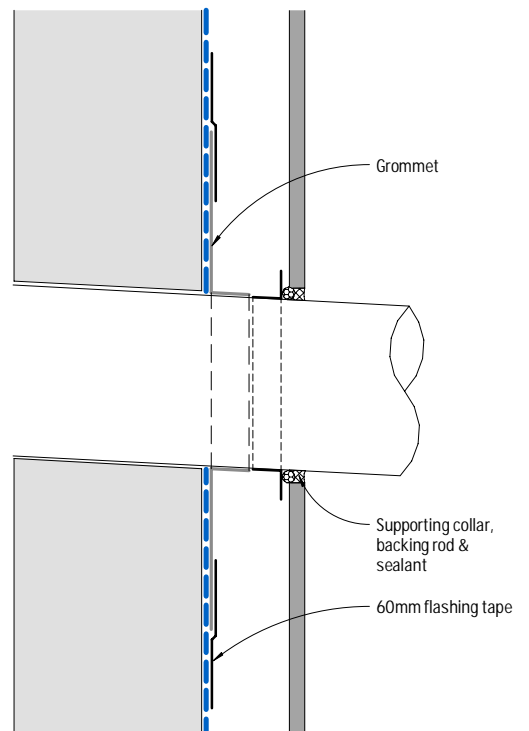

Figure 30: Pipe penetration - Section

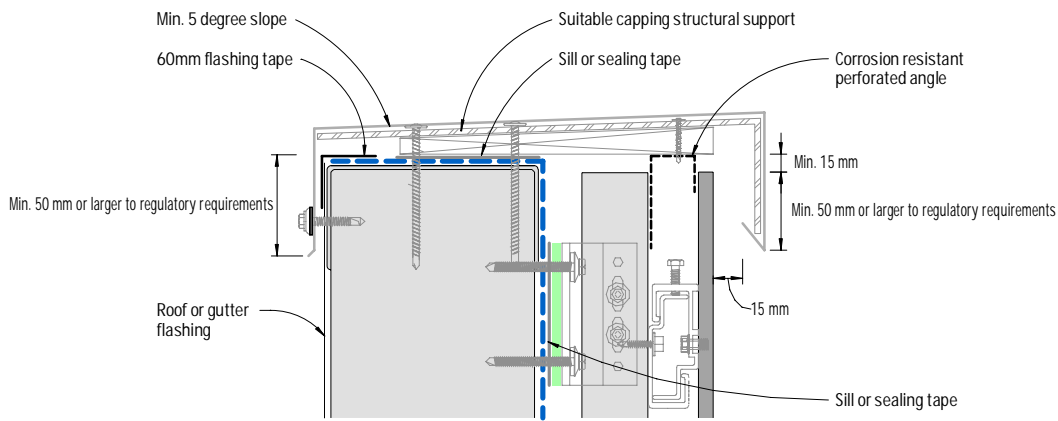

Figure 31: Capping - Detail 1

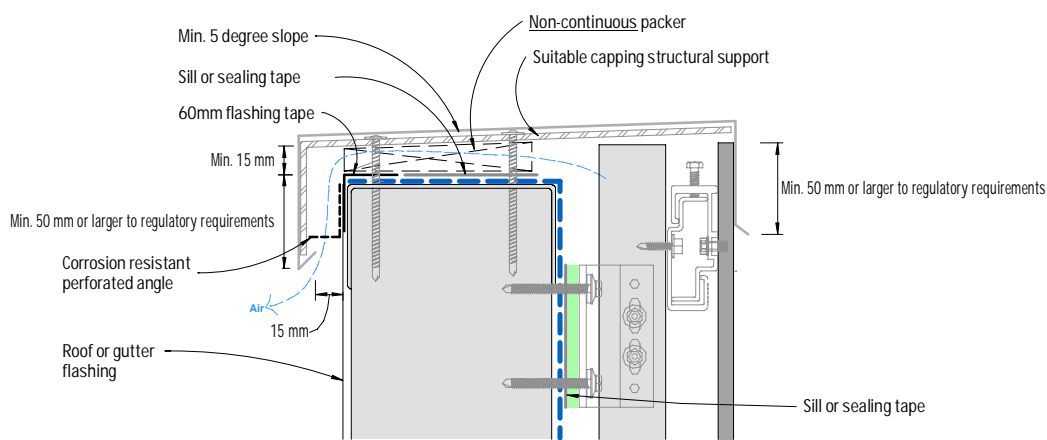

Figure 32: Capping - Detail 2  
(Not suitable for EQUITONE [material])

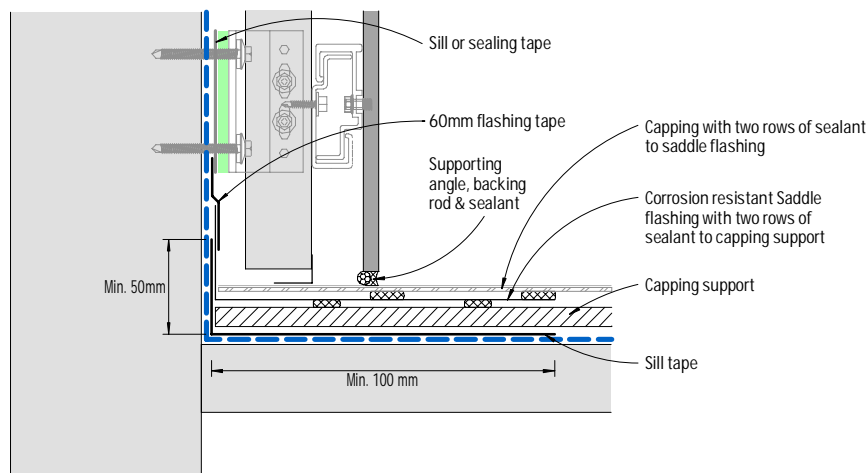

Figure 33: Parapet junction - Section

Notes

- 1) For EQUITONE [material], the following capping dimensions should be followed.
  - A minimum 20mm between panel face and rear of the capping
  - A minimum 50mm overlap with the panel for building up to 8m or larger to regulatory requirements.
  - A minimum 80mm overlap with the panel for building up to 20m or larger to regulatory requirements.
  - A minimum 100mm overlap with the panel for building over 20m or larger to regulatory requirements.
- 2) Any face fixings of capping shall be through an over sized hole (by min 5mm) in the capping as well as the panel.
- 3) Corrosion resistant perforated angle shall be of max. thickness of 0.9mm where located between panel and support frame, and be of min. 50% open area with aperture size of 3-5mm.
- 4) Capping shall be designed and engineered accordingly to provide adequate allowance for ventilation as shown in Figures 31 & 32.



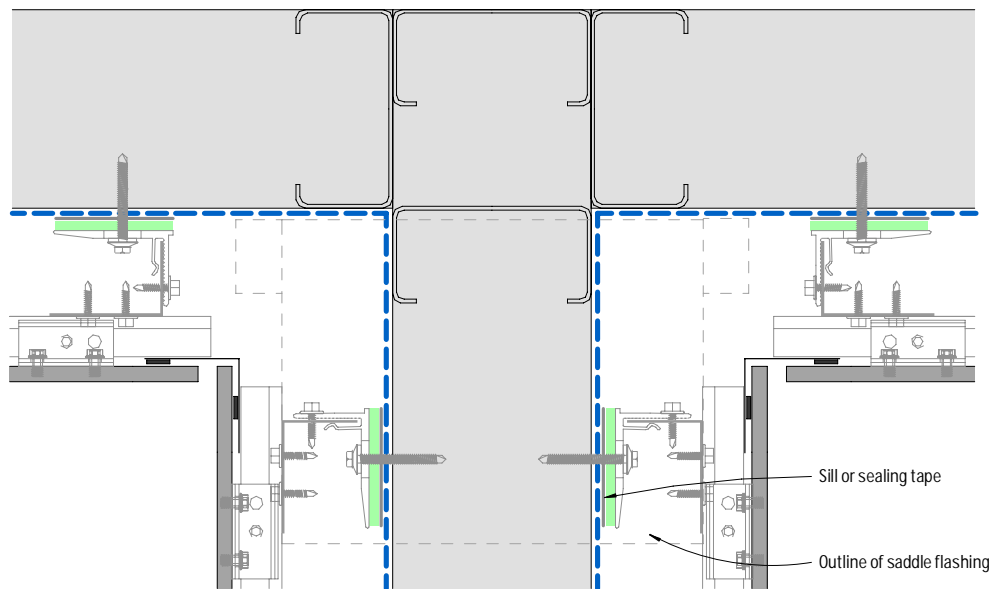

Figure 34: Parapet junction - Plan view

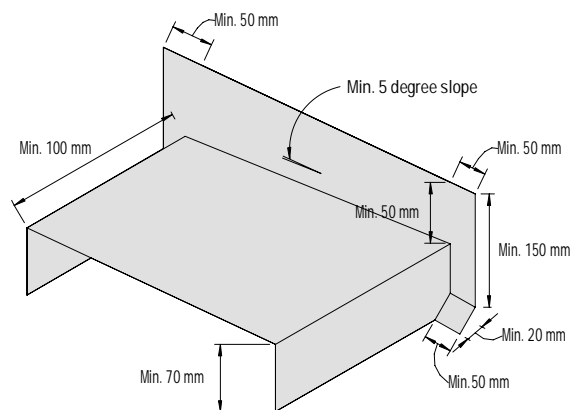
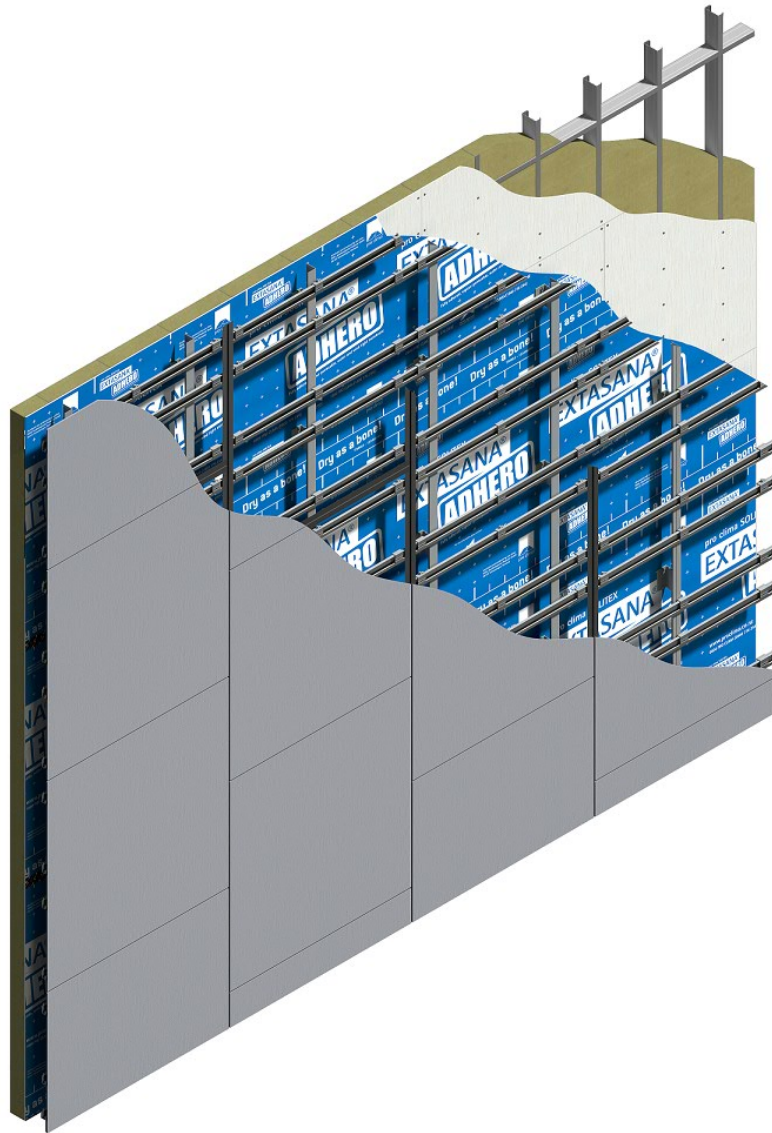

Figure 35: Corrosion resistant saddle flashing

# EQUITONE system



rigid air barrier  
concealed fixing system

# Drawings index

| Detail   | Figure | Page |
|--|--------|------|
| Baffled horizontal joint   | 1      | 28   |
| Baffled horizontal joint junction with vertical joint - Elevation  | 2      | 28   |
| Open horizontal joint  | 3      | 28   |
| Open horizontal joint junction with vertical joint - Elevation     | 4      | 28   |
| Vertical joint - Detail 1  | 5      | 29   |
| Vertical joint - Detail 2  | 6      | 29   |
| Intermediate panel fixings connection                              | 7      | 29   |
| Horizontal control joint   | 8      | 30   |
| Vertical control joint   | 9      | 30   |
| Flush window - Head and sill                                       | 10     | 31   |
| Flush window - Jamb  | 11     | 31   |
| Recessed window - Head and sill                                    | 12     | 32   |
| Recessed window jamb - Option 1                                    | 13     | 32   |
| Recessed window jamb - Option 2                                    | 14     | 32   |
| Meter box - Section  | 15     | 33   |
| Meter box - Plan view - Detail 1                                   | 16     | 33   |
| Meter box - Plan view - Detail 2                                   | 17     | 33   |
| Isometric view of window/meter box opening - Tape application      | 18     | 34   |
| Soffit junction  | 19     | 34   |
| Base detail  | 20     | 35   |
| Base detail - Covered area   | 21     | 35   |
| Base detail - Balcony  | 22     | 35   |
| Junction with other materials - flush detail                       | 23     | 36   |
| Junction with other materials, eaves or the like - recessed detail | 24     | 36   |
| Exposed concrete slab or beam - Cladding flush                     | 25     | 37   |
| Exposed concrete slab or beam - Cladding recessed                  | 26     | 37   |
| External corner  | 27     | 38   |
| Abutment   | 28     | 38   |
| Internal corner  | 29     | 38   |
| Pipe penetration - Plan view                                       | 30     | 39   |
| Pipe penetration - Elevation                                       | 31     | 39   |
| Pipe penetration - Section   | 32     | 39   |
| Capping - Detail 1   | 33     | 40   |
| Capping - Detail 2   | 34     | 40   |
| Parapet junction - Section   | 35     | 40   |
| Parapet junction - Plan view                                       | 36     | 41   |
| Corrosion resistant saddle flashing                                | 37     | 41   |

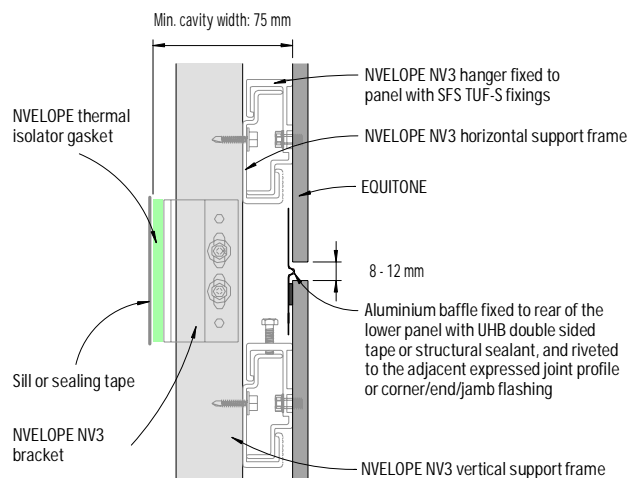

Figure 1: Baffled horizontal joint  
(Not suitable for EQUITONE [material])

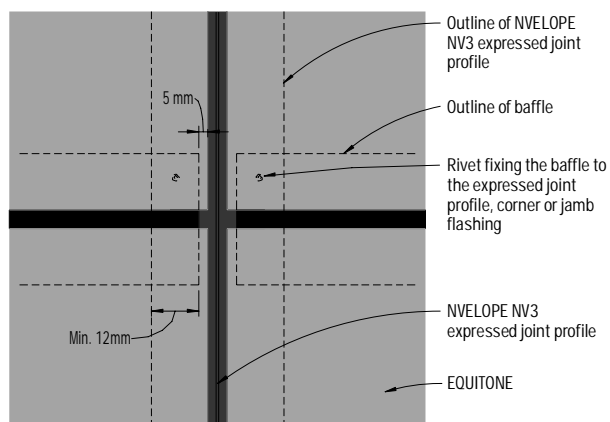

Figure 2: Baffled horizontal joint  
junction with vertical joint - Elevation

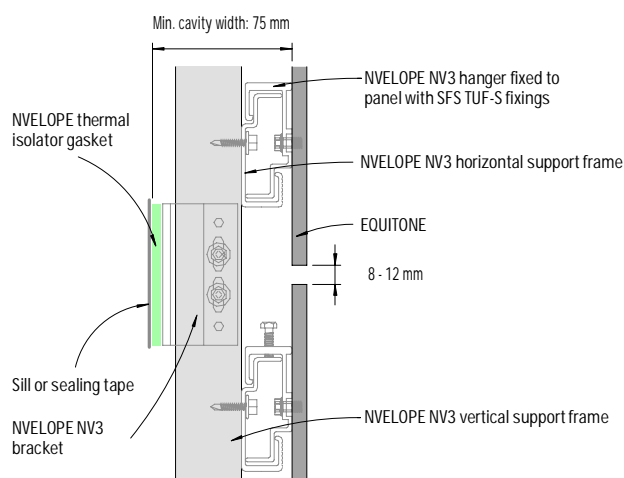

Figure 3: Open horizontal joint

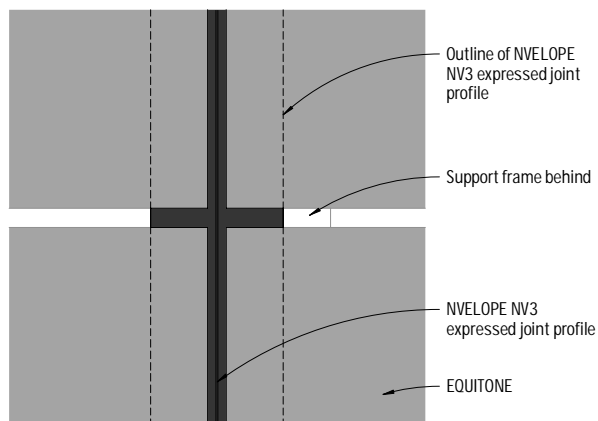

Figure 4: Open horizontal joint junction  
with vertical joint - Elevation

Notes

- 1) Horizontal open joint detail (Figure 3 & 4) requires project engineer's evaluation and approval, and the selection of appropriate UV resistant weather resistive barrier (membrane).
- 2) In Figure 4, visible part of the support frame profiles and weather barrier may be coated black with suitable paint.
- 3) The length of NVELOPE NV3 vertical and horizontal rail, and expressed joint profile must NOT exceed 3,150mm.

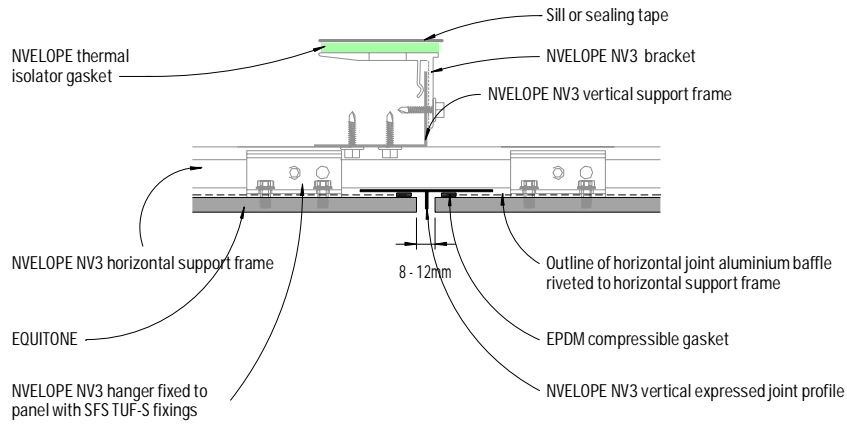

Figure 5: Vertical joint - Detail 1

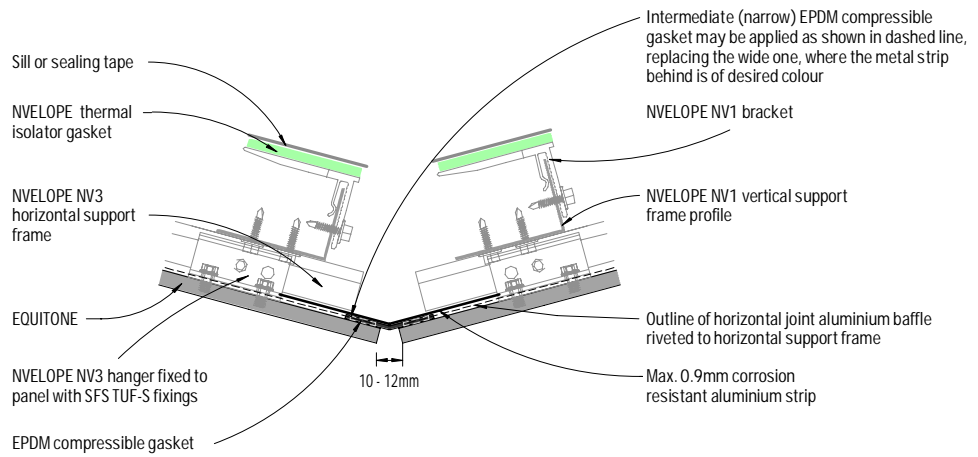

Figure 6: Vertical joint - Detail 2

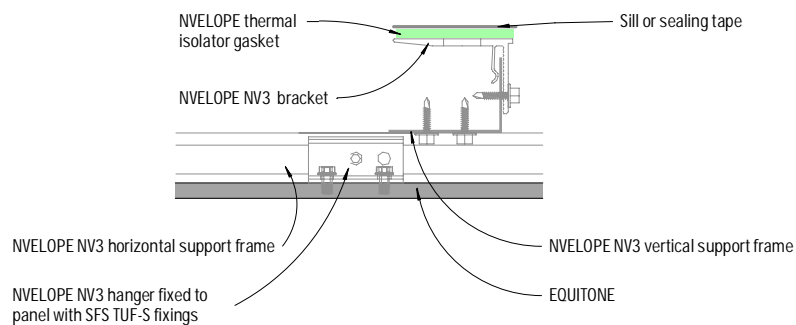

Figure 7: Intermediate panel fixings connection

Notes

1) The deflection of NVELOPE NV3 vertical expressed joint profile (as included in Figure 5) and any aluminium strip located at the vertical joint (as included in Figure 6) shall be limited to an extent ensuring the seal along the vertical joint is maintained with respect to project wind loading.

2) The aluminium strip should be fixed ONLY to one of the support frame profiles (either left or right) where allowance for horizontal and/or vertical movement of the cladding frame is required.

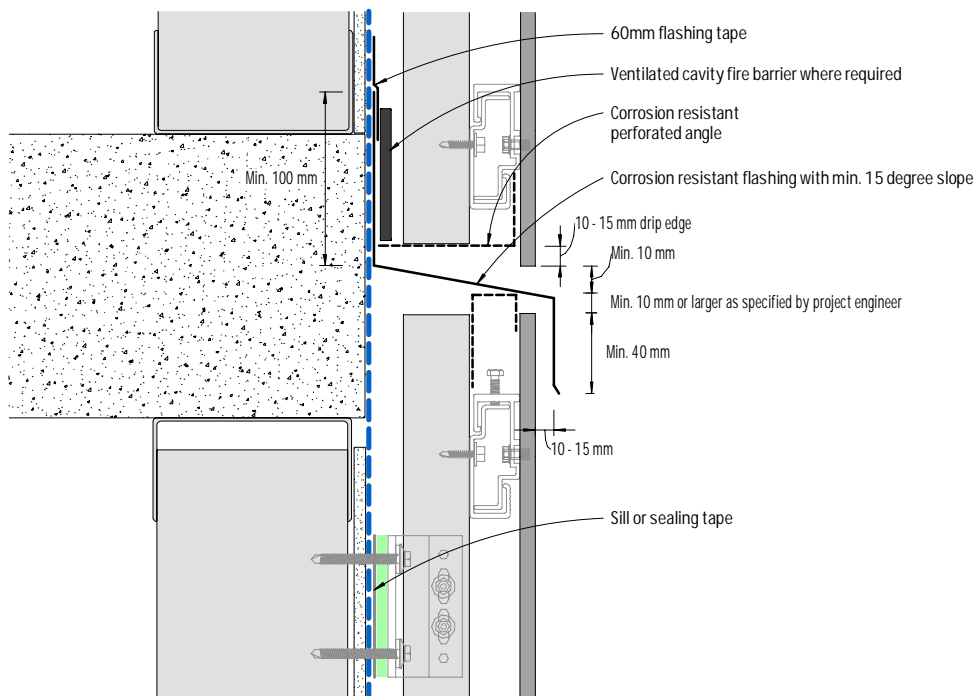

Figure 8: Horizontal control joint

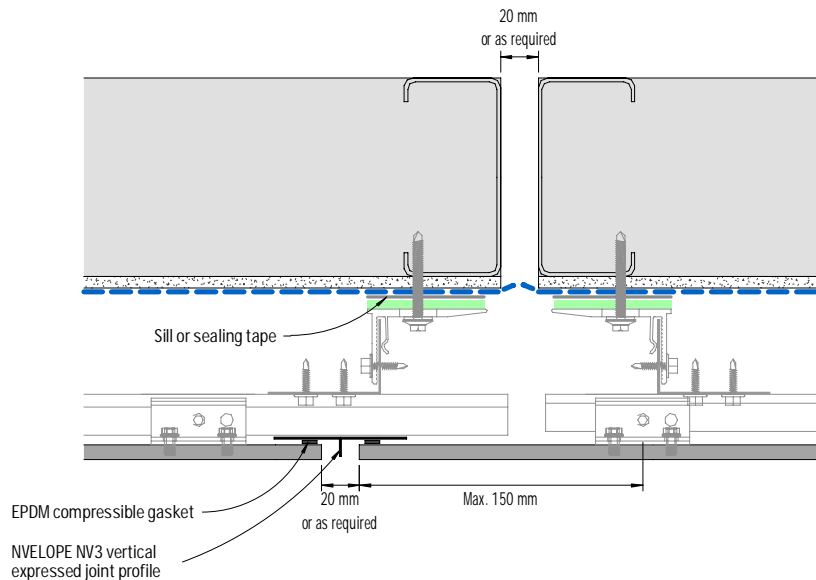

Figure 9: Vertical control joint

#### Notes

- 1) Support frame profiles and rigid air barrier must NOT be fixed crossing over a control joint.
- 2) The deflection of NVELOPE NV3 vertical expressed joint profile shall be limited to an extent ensuring the seal along the vertical joint is maintained with respect to project wind loading.
- 3) Allowance for movement at the location of any control joint must be made in the cladding and its support frame design and installation. Panel must NOT be fixed bridging over any control joint.
- 4) Corrosion resistant perforated angle shall be of max. thickness of 0.9mm where located between panel and support frame, and be of min. 50% open area with aperture size of 3-5mm.

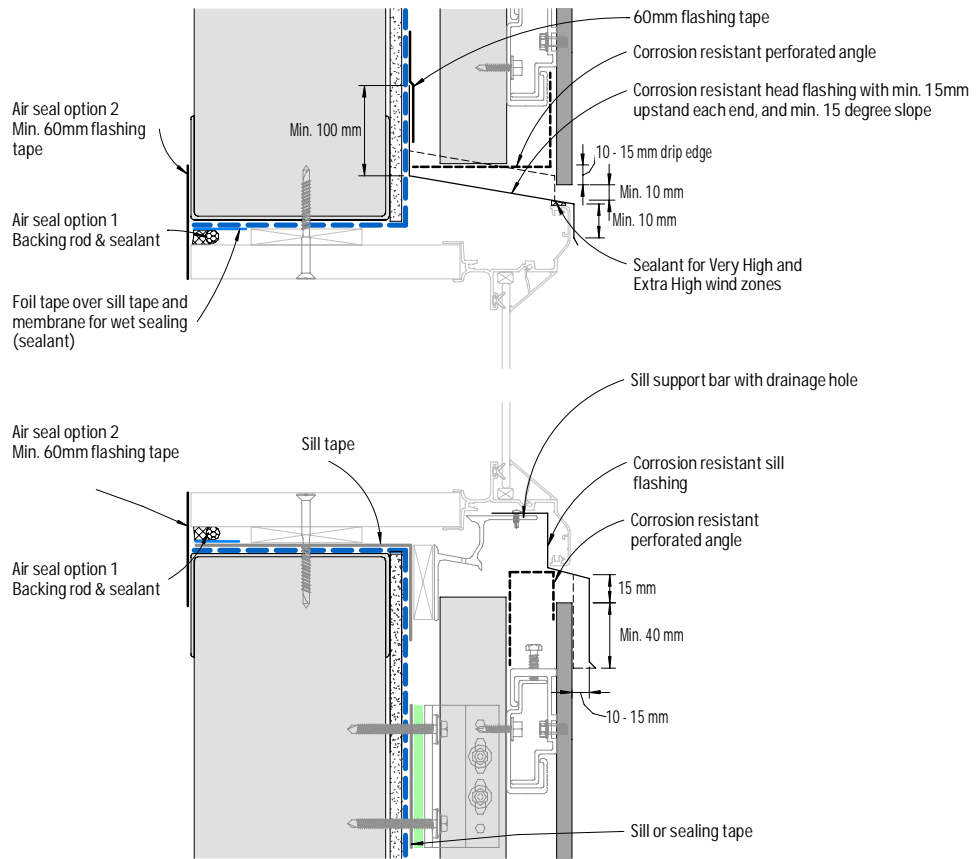

Figure 10: Flush window - Head and sill

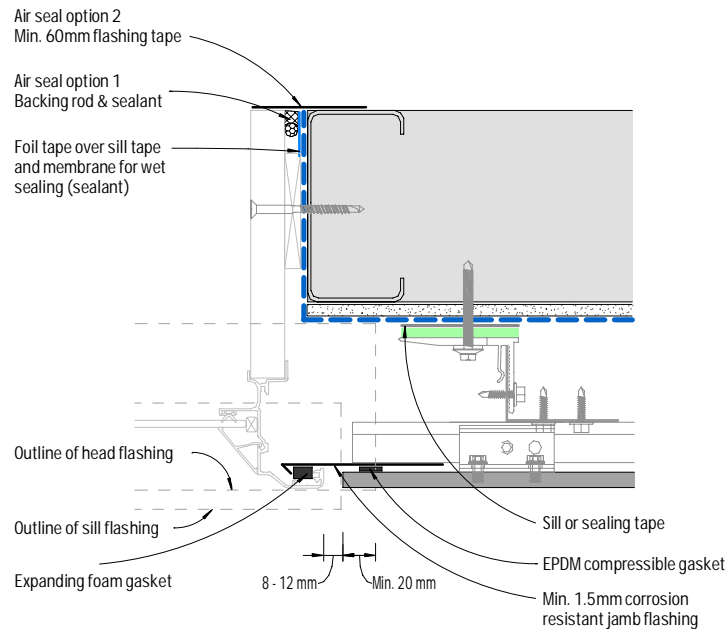

Figure 11: Flush window - Jamb

Notes

- 1) ONLY sealant compatible with the foil tape should be used. Should any sealant be intended to be used directly on the flashing and/or sill tape it must be confirmed with its manufacturer to ensure compatibility with these tapes in accordance with the relevant standards.
- 2) Corrosion resistant perforated angle shall be of max. thickness of 0.9mm where located between panel and support frame, and be of min. 50% open area with aperture size of 3-5mm.

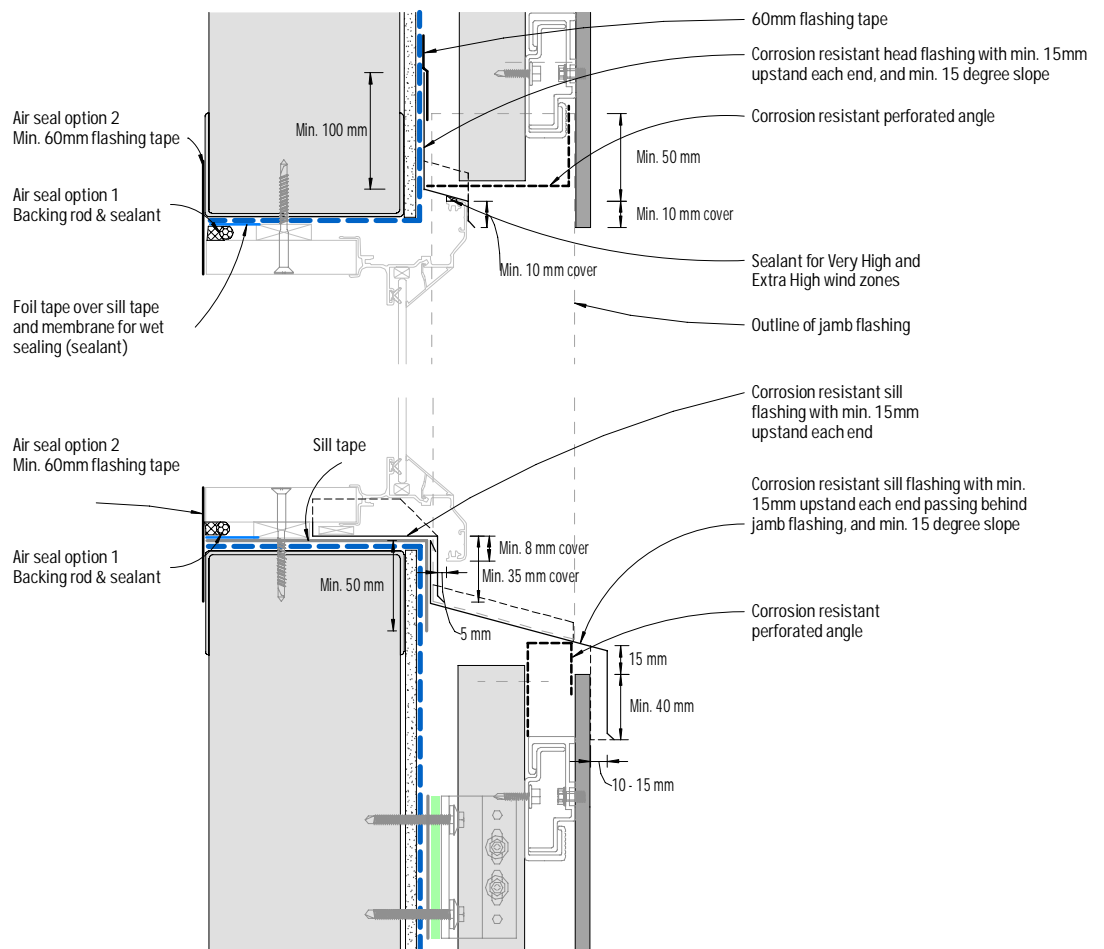

Figure 12: Recessed window - Head and sill

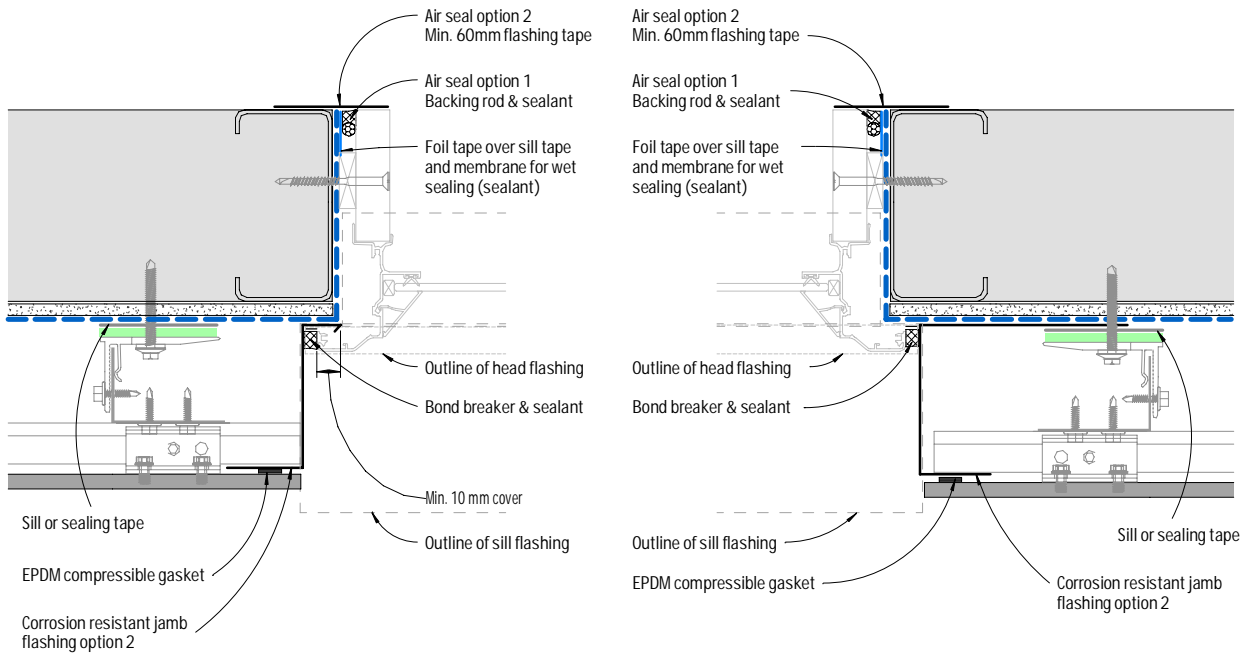

Figure 13: Recessed window jamb - Option 1

Figure 14: Recessed window jamb - Option 2

Notes

- 1) ONLY sealant compatible with the foil tape should be used. Should any sealant be intended to be used directly on the flashing and/or sill tape it must be confirmed with its manufacturer to ensure compatibility with these tapes in accordance with the relevant standards.
- 2) Corrosion resistant perforated angle shall be of max. thickness of 0.9mm where located between panel and support frame, and be of min. 50% open area with aperture size of 3-5mm.



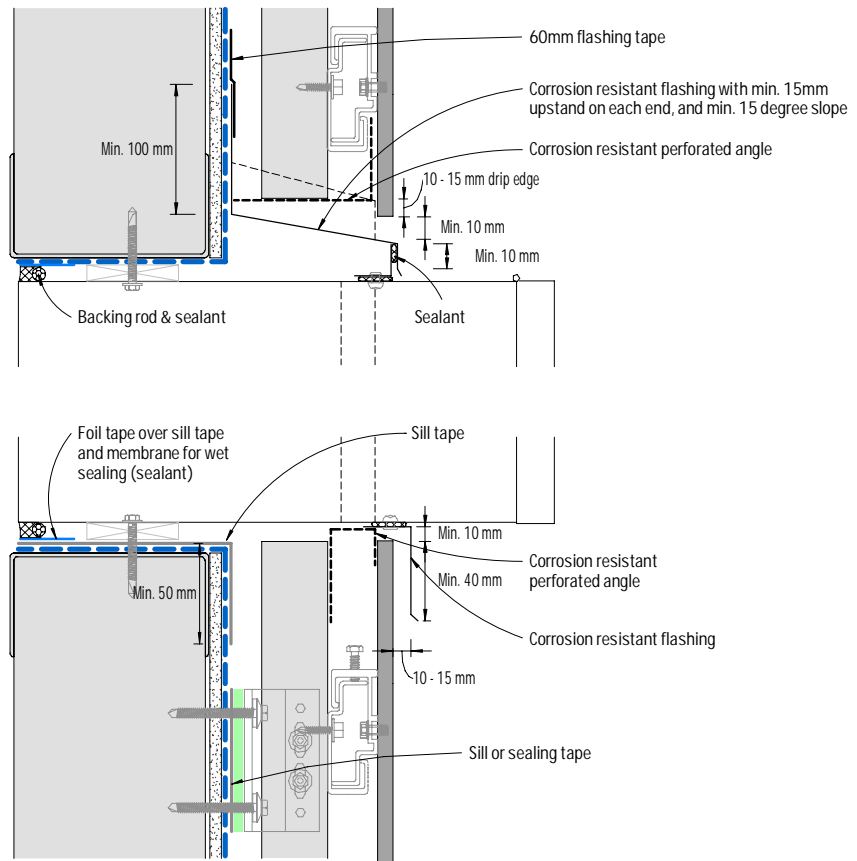

Figure 15: Meter box - Section

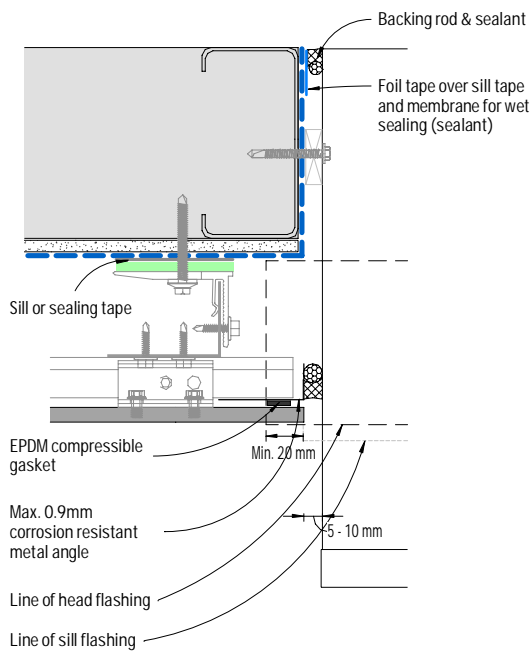

Figure 16: Meter box - Plan view - Detail 1

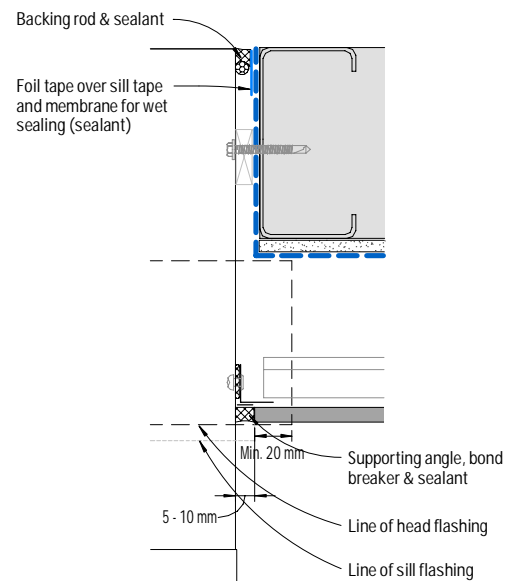

Figure 17: Meter box - Plan view - Detail 2

Notes

- 1) ONLY sealant compatible with the foil tape should be used. Should any sealant be intended to be used directly on the flashing and/or sill tape it must be confirmed with its manufacturer to ensure compatibility with these tapes in accordance with the relevant standards.
- 2) Corrosion resistant perforated angle shall be of max. thickness of 0.9mm where located between panel and support frame, and be of min. 50% open area with aperture size of 3-5mm.

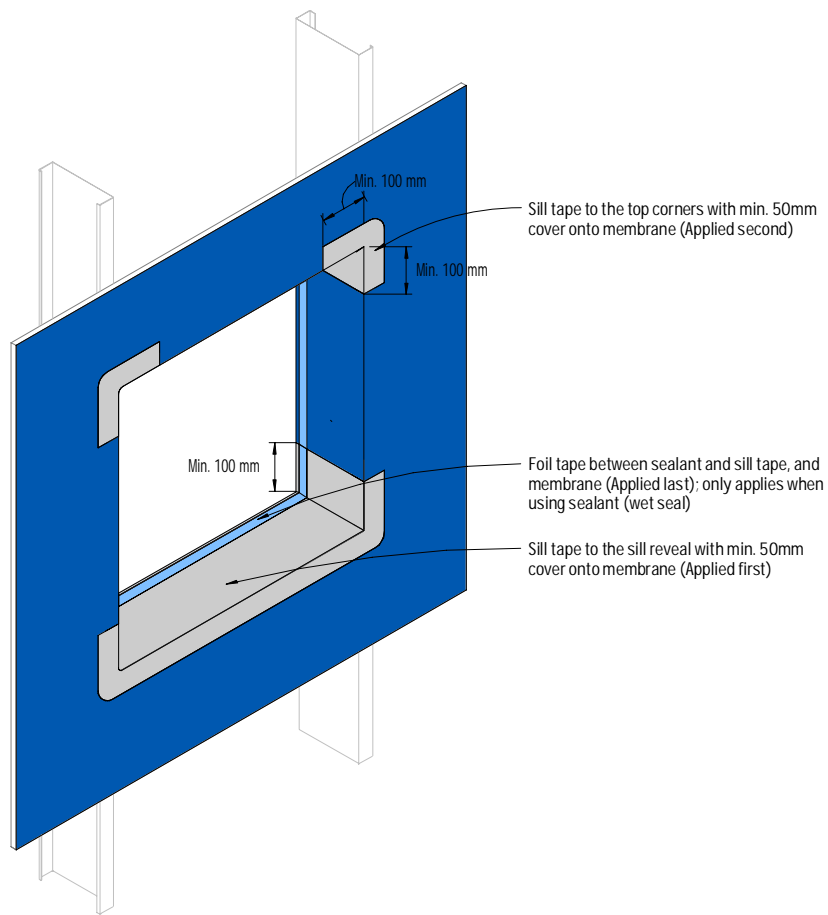

Figure 18: Isometric view of window/meter box opening - Tape application

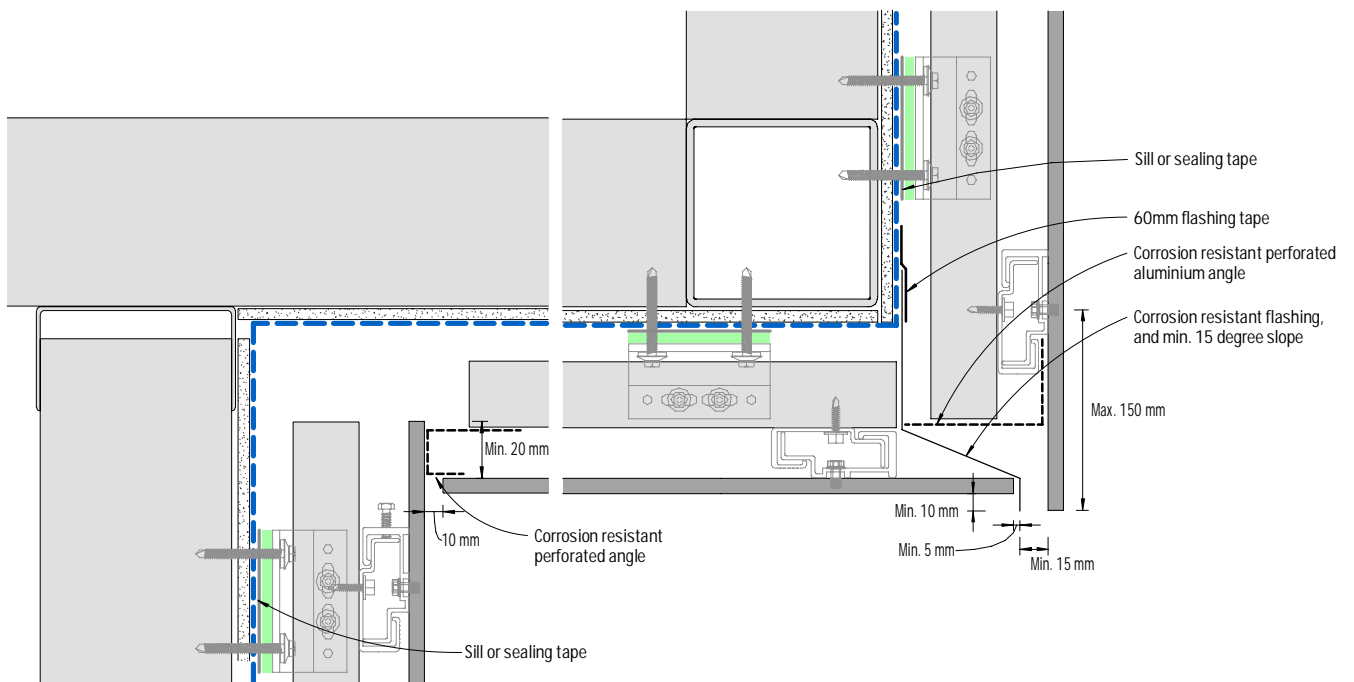

Figure 19: Soffit junction

Notes

- 1) ONLY sealant compatible with the foil tape should be used. Should any sealant be intended to be used directly on the flashing and/or sill tape it must be confirmed with its manufacturer to ensure compatibility with these tapes in accordance with the relevant standards.
- 2) Support frame profiles and rigid air barrier must NOT be fixed crossing over a control joint.
- 3) Corrosion resistant perforated angle shall be of max. thickness of 0.9mm where located between panel and support frame, and be of min. 50% open area with aperture size of 3-5mm.

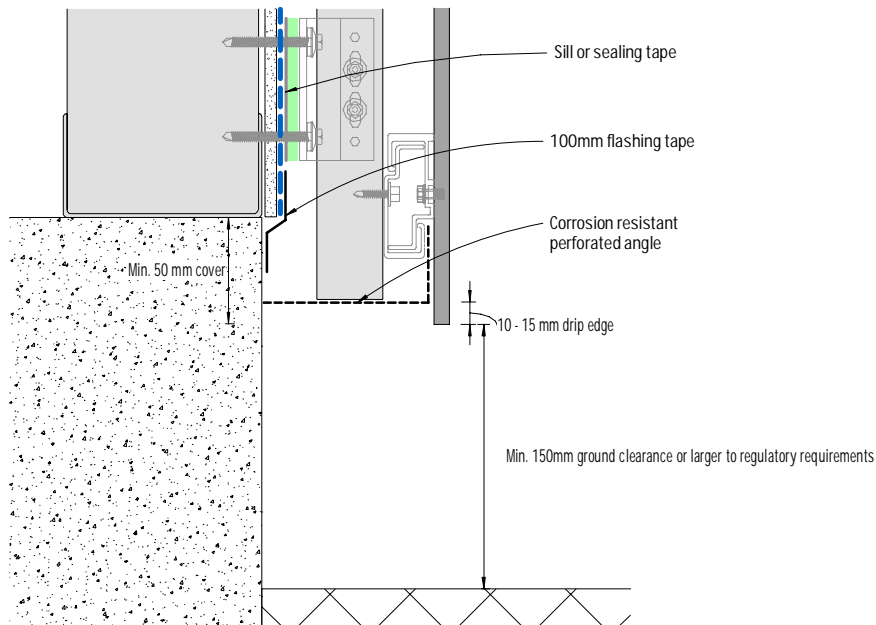

Figure 20: Base detail

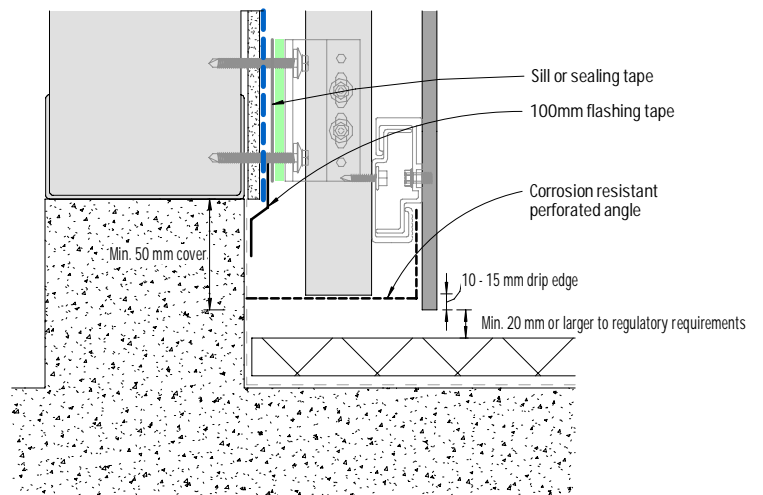

Figure 21: Base detail - Covered area

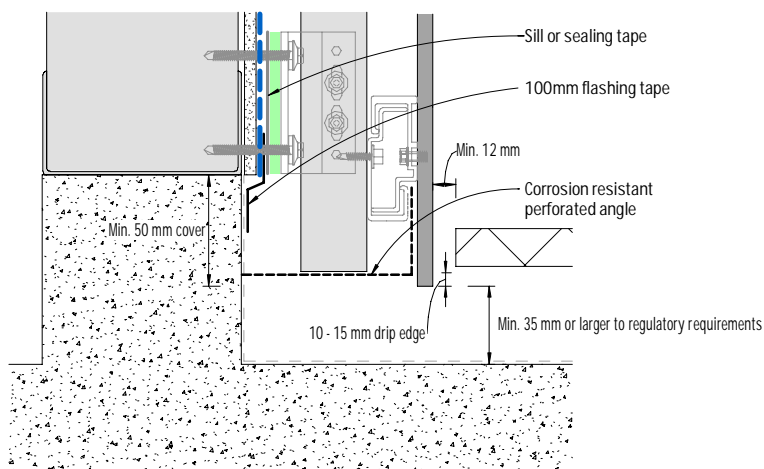

Figure 22: Base detail - Balcony

Notes

1) For **EQUITONE [materia]**, minimum ground clearance is **300mm**.

2) Corrosion resistant perforated angle shall be of max. thickness of 0.9mm where located between panel and support frame, and be of min. 50% open area with aperture size of 3-5mm.

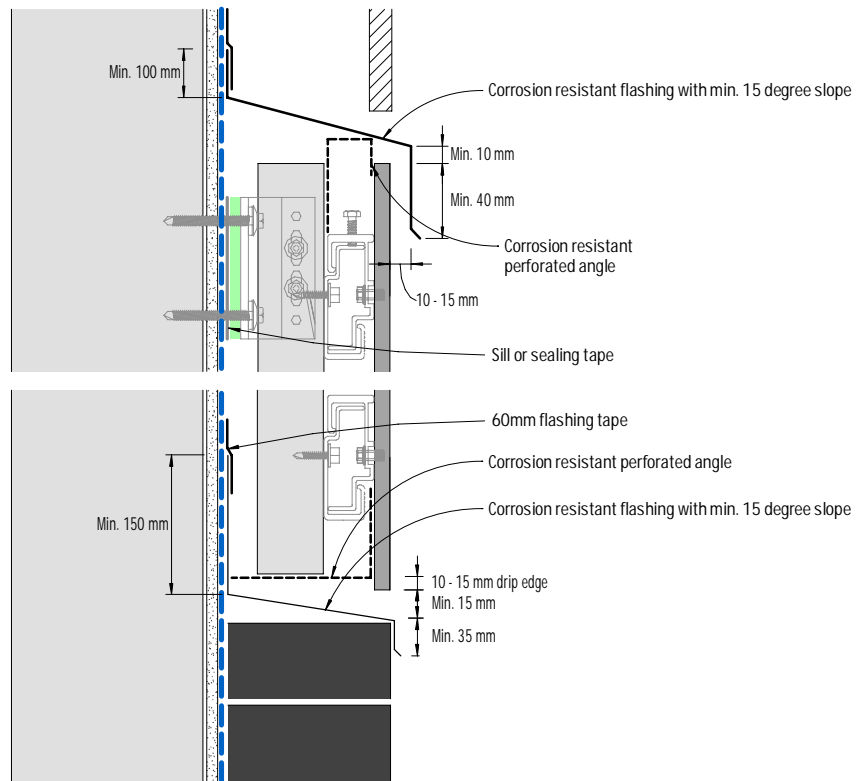

Figure 23: Junction with other materials - flush detail

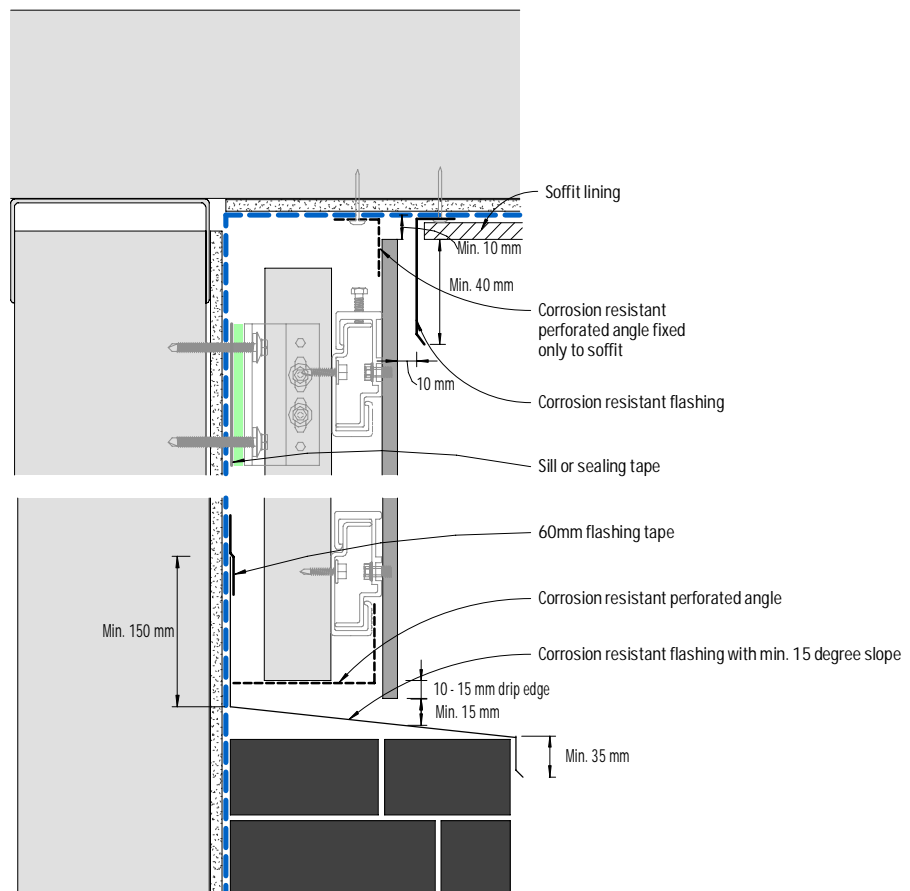

Figure 24: Junction with other materials, eaves or the like - recessed detail

Notes

- 1) Support frame profiles and rigid air barrier must NOT be fixed crossing over a control joint.
- 2) Corrosion resistant perforated angle shall be of max. thickness of 0.9mm where located between panel and support frame, and be of min. 50% open area with aperture size of 3-5mm.

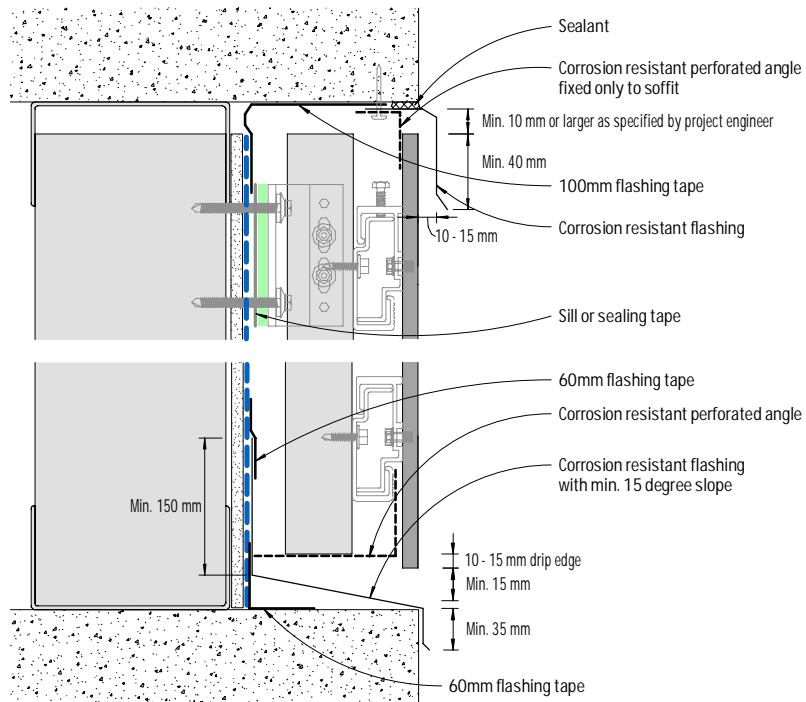

Figure 25: Exposed concrete slab or beam - Cladding flush

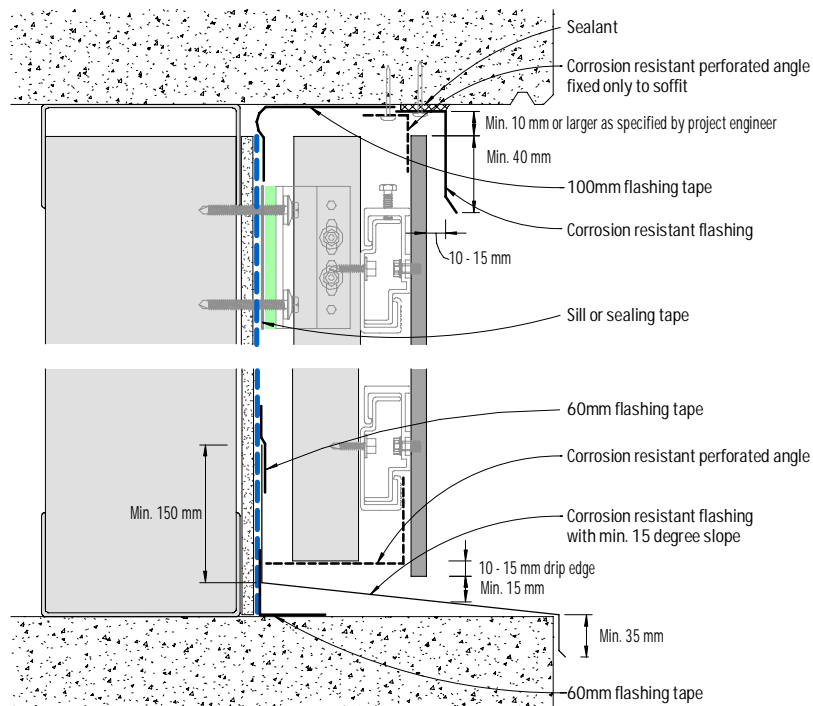

Figure 26: Exposed concrete slab or beam - Cladding recessed

Notes

- 1) Refer to Pro Clima's flashing tape application guide for any pre-treatment required on concrete or masonry for the application of the flashing tape onto these substrates.
- 2) Support frame profiles and rigid air barrier must NOT be fixed crossing over a control joint.
- 3) Corrosion resistant perforated angle shall be of max. thickness of 0.9mm where located between panel and support frame, and be of min. 50% open area with aperture size of 3-5mm.

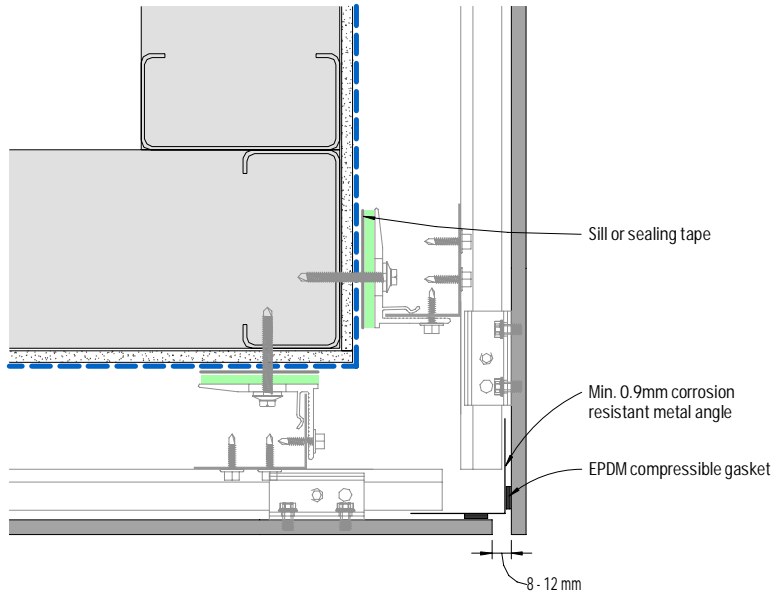

Figure 27: External corner

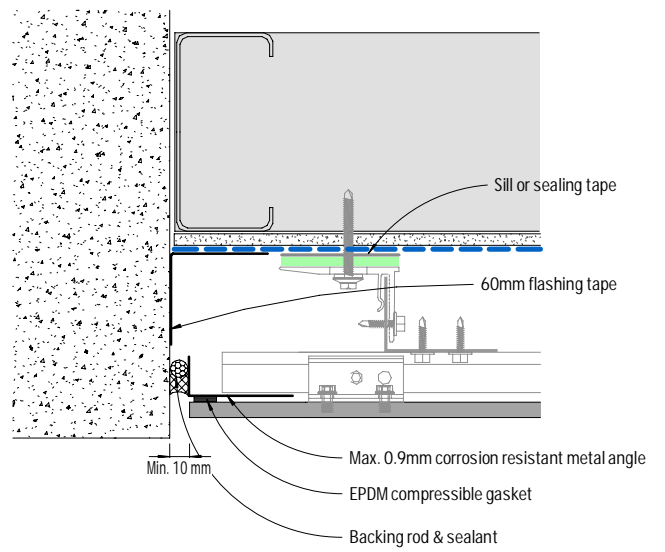

Figure 28: Abutment

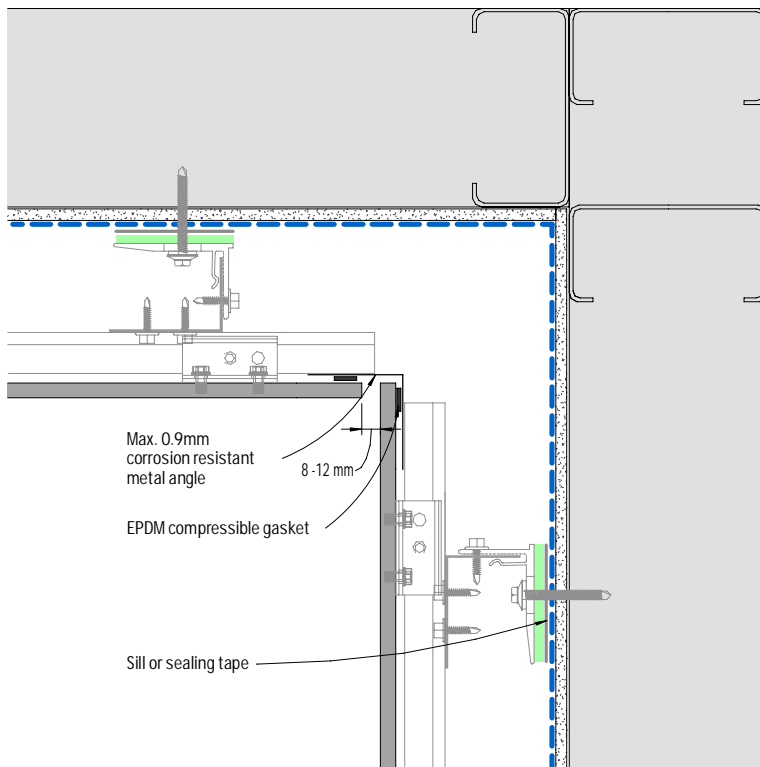

Figure 29: Internal corner

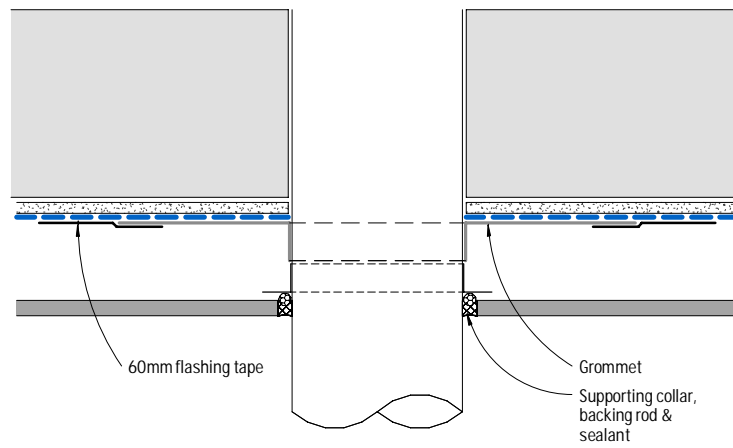

Figure 30: Pipe penetration - Plan view

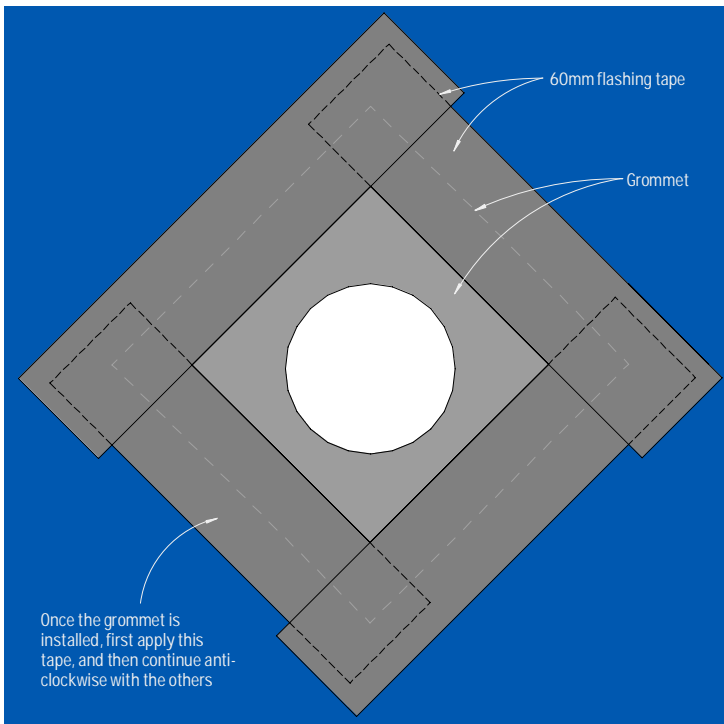

Figure 31: Pipe penetration - Elevation

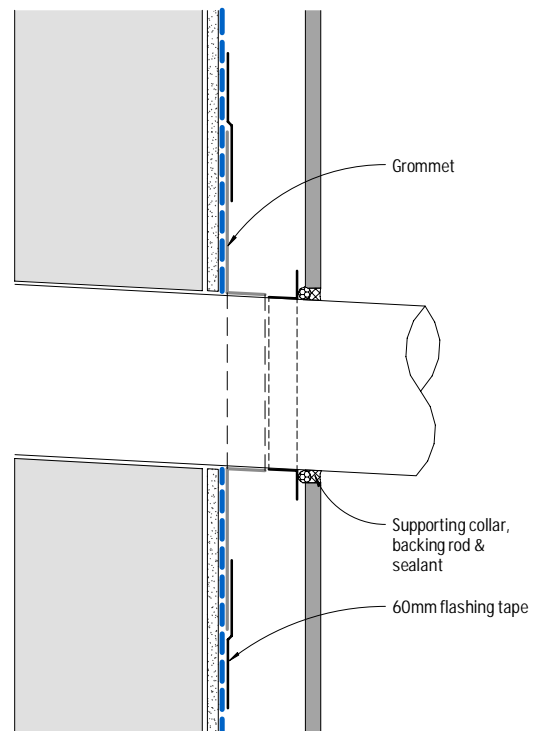

Figure 32: Pipe penetration - Section

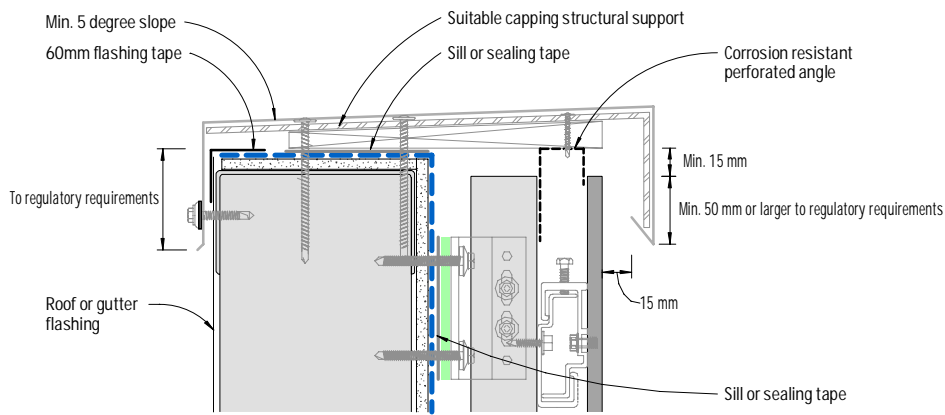

Figure 33: Capping - Detail 1

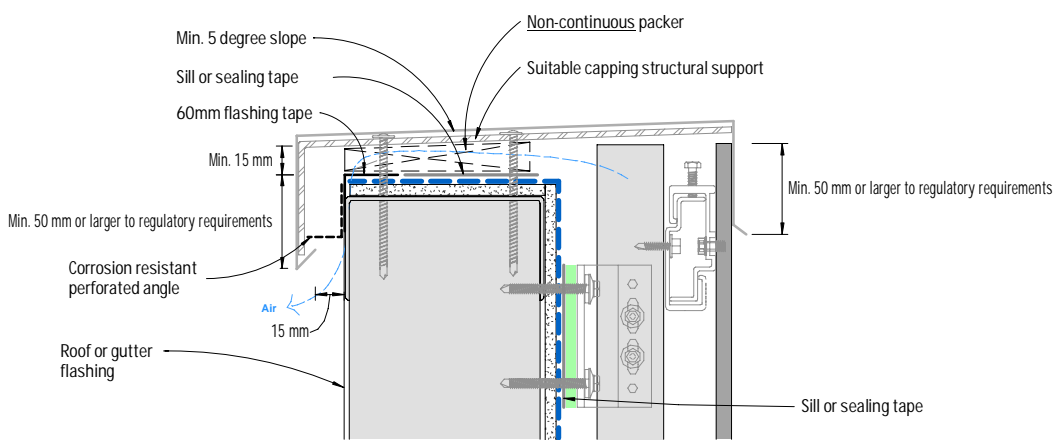

Figure 34: Capping - Detail 2  
(Not suitable for EQUITONE [material])

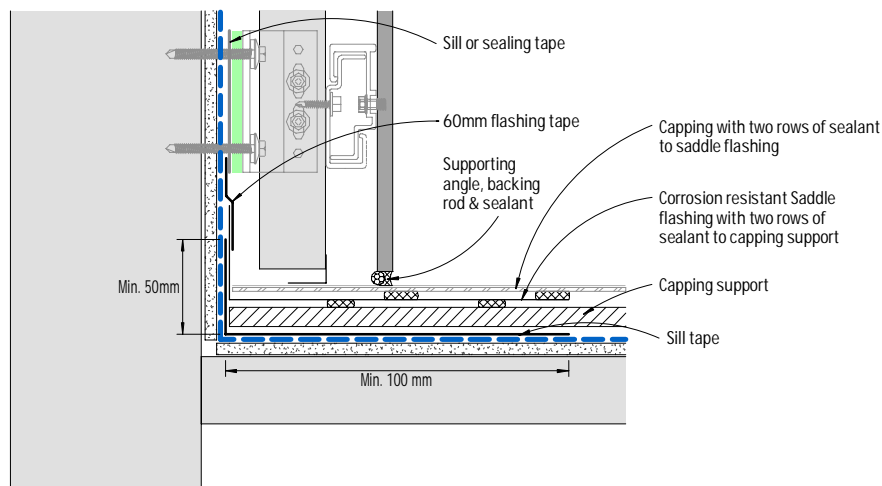

Figure 35: Parapet junction - Section

Notes

- 1) For EQUITONE [material], the following capping dimensions should be followed.
  - A minimum 20mm between panel face and rear of the capping
  - A minimum 50mm overlap with the panel for building up to 8m or larger to regulatory requirements.
  - A minimum 80mm overlap with the panel for building up to 20m or larger to regulatory requirements.
  - A minimum 100mm overlap with the panel for building over 20m or larger to regulatory requirements.
- 2) Any face fixings of capping shall be through an over sized hole (by min 5mm) in the capping as well as the panel.
- 3) Corrosion resistant perforated angle shall be of max. thickness of 0.9mm where located between panel and support frame, and be of min. 50% open area with aperture size of 3-5mm.
- 4) Capping shall be designed and engineered accordingly to provide adequate allowance for ventilation as shown in Figures 33 & 34.



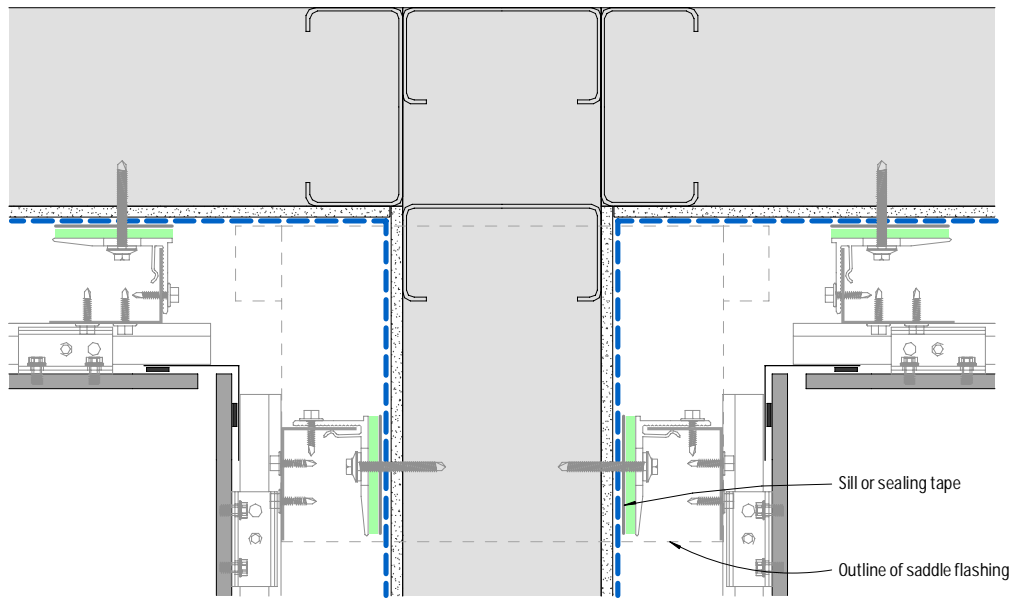

Figure 36: Parapet junction - Plan view

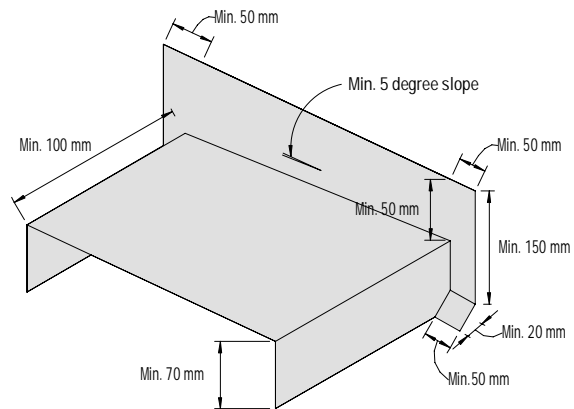

Figure 37: Corrosion resistant saddle flashing

The logo for EQUITONE system features a stylized icon of three horizontal bars of varying lengths on the left, followed by the word "EQUITONE" in a bold, uppercase, sans-serif font, and the word "system" in a lowercase, sans-serif font to its right.

EQUITONE ANZ  
10-20 Jordan Close  
Altona VIC 3018  
Australia

+61 (03) 9988 2290  
[info.australia@equitone.com](mailto:info.australia@equitone.com)  
[equitone.com](http://equitone.com)