



 **EQUITONE**
Fibre cement facade materials

APPLICATION

An Introduction to This Manual

This application guide was written to illustrate designing, specifying, and installing the EQUITONE range of fiber-cement panels is straightforward, assuming some simple rules are followed. This guide intends to provide information not covered in the EQUITONE Design Guide and installation procedures.

For ease of use, this guide is divided into several sections. The information published in this guide should serve as amplifying or clarifying product and application guidance including design, layout, use, maintenance, and special applications.

The United States consists of many regions, some with unique requirements and regulations; therefore, this guide does not address all local issues but highlights what is generally needed when designing the façade.

The information in this guide is comprehensive, but not exhaustive, and more information can be found via EQUITONE's experienced and knowledgeable service teams.

Please note, metric values listed take precedence over imperial values. All information is subject to change without notice. Please contact EQUITONE for additional information.

www.equitone.com
info.usa@equitone.com



Table of Contents

Manufacturing Plants.....	5
Manufacturing Process	7
Sustainability	10
The History of the Ventilated Façade	12
Etex Panel History	13
The Ventilated Façade/Rainscreen	14
Site Work	17
Health & Safety	17
Storage.....	17
Handling.....	17
Transport	18
Tools & Accessories.....	19
Centralizing Tool.....	19
Rivet Setting Tool	19
Electronic Rivet Fastener	19
Drills, Bits, Saws & Blades	19
CNC Machines	20
Milling Tool (for EQUITONE [linea] LT)	20
Clamps/Suction Cups/Handles.....	21
Spacers.....	21
Support Rails.....	21
Foam Tape	21
Luko Sealant	21
Horizontal Joint Profiles	22
Corner Profiles.....	22
Fasteners	24
EQUITONE Uni-Rivets	24
Uni-Rivet Sleeves.....	24



EQUITONE Uni-Screws	25
Uni-Screw Sleeves	25
Tergo+ (Concealed Fasteners)	25
SFS Tuf-S (Concealed Fastener).....	26
Panel Drilling	27
Panel Cutting	27
Edge Treatment.....	30
Sanding	30
Luko Sealant Application Procedure –.....	30
for [natura]/[natura] PRO only	30
Cleaning & Maintenance.....	31
Supporting Frame Design.....	35
Aluminum Support Frame.....	37
Other Aluminum Systems	38
Galvanized Support Frame.....	39
Metal Supporting Frame Details.....	40
Design Considerations.....	45
Panel Layout	45
Cavity	46
Joints.....	47
Edge Spacing	49
Walls	52
Insulation	54
Wind	57
Special Applications	59
Draft Specification.....	63



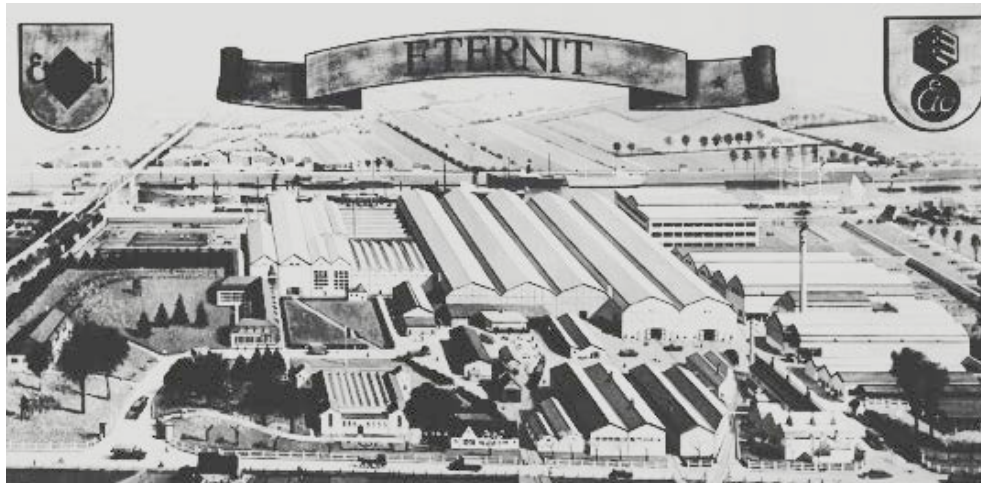

Manufacturing Plants

General

Etex is unique amongst fiber-cement manufacturers in that it specializes in both air-cured and autoclaved, high-density flat panels. The manufacturing process for fiber-cement has virtually remained the same for over 100 years; only the ingredients used have changed over time. These high-performance ingredients result in products which are:

- Lightweight
- Strong
- Durable
- Fire-resistant
- Frost-proof
- Fungi- and insect-resistant
- Low-maintenance
- Aesthetically pleasing

Since the early days, many millions of square meters of fiber-cement products have been installed on façades, withstanding extreme climatic conditions globally. Large-sized fiber-cement panels, for back-ventilated façades, have proven to be successful in everyday use.

Production Plants

Today, the plant in Neubeckum, Germany covers over 74 acres (30ha) and is a specialist in air-cured technology. The plant began production, in 1963, and, today, runs the largest Hatschek machine in the world, which is dedicated to the production of the EQUITONE air-cured panels.



The most advanced autoclaved technology is used for the EQUITONE [tectiva] panels, produced in Kapelle op den Bos, Belgium. This manufacturing plant moved to this site, in 1924, once it had out-grown its previous factory. Its location was ideal as it is adjacent to the canal and railway. The canal is proving to be a real benefit as it now, again, is the supply route for raw materials; therefore, reducing the factory's CO₂ footprint.



Standards & Certificates

Both manufacturing facilities hold the latest versions of the following ISO certificates:

ISO 9001: Quality Management System
ISO 14001: Environmental Management System
OHSAS 18001: Safety Management System

All EQUITONE panels are manufactured in accordance with the requirements of EN12467 "Fibre-cement flat sheets. Product specification and test methods."

This standard establishes the standards that all fiber-cement panels should meet. In addition to this, all EQUITONE panels are labelled with CE marking in accordance with this standard. This further ensures the products conform to the highest standards.

The CE marking is the sole evidence of conformity required by law. The CE marking displays the following information:

The CE marking symbol
Details of the manufacturer (address) and year of manufacture
Coded information on certain product properties
Declaration of conformity by the manufacturer

The CE marking is a kind of "technical passport". Products bearing the CE marking can be traded within the European Union market. The manufacturer is responsible for affixing the CE marking.

In addition to the manufacturing certificates and European approvals, local approvals are also needed for some countries. Examples are Irish Agrément Board, British Agrément Board, Avis Technique from France, Zulassung from Germany, ATG from Belgium, and KOMO from Netherlands. Many of these approvals are acceptable in other countries.



To remain current and involved with the latest developments, and to promote ventilated façades, some of our sales organizations are also active members of their local institutes, such as the FHFV in Germany, CWCT in UK, or the CSTB in France.

In the United States, EQUITONE has achieved certification via the International Code Council (ICC-ES) for compliance with International Building Code and specific state/city codes.



K41115



Manufacturing Process

General

Fiber-cement is, again, a modern reinforced material. The sum of this material's positive characteristics fulfils today's high expectations for construction and design. This technology for façade panels spawns from many decades of development, testing, and experience in the laboratory and actual long-term real-life use.

Fiber-Cement

All EQUITONE Fiber-cement panels are manufactured by the Hatschek process. The base mixture can be of cement, sand, cellulose, and water (autoclaved), or cement, lime, synthetic fibers, and water (air-cured). These materials are mixed together to create a slurry. The fluid mixture is then supplied to a holding tank which has several rotating screen cylinders. These cylinders pick up the solid matter removing some of the water in the operation. A belt travels over the top surfaces of the cylinders and picks up a thin layer of fiber-cement formulation from each cylinder. The built-up laminated ply then travels over vacuum dewatering devices which remove most of the water. The moving belt carries the damp material to a forming drum, around which the successive layers are wound, until the required thickness is obtained. Once the desired sheet



thickness has been obtained, an automatic cutting knife, built into the forming drum, is activated, and the “green” raw sheet exits onto a conveyor, which subsequently transfers it to a stack. The damp sheets are stacked and separated with steel plates. The stacked panels then enter the press, which delivers a pressure of at least 13,227 tons (12,000 metric tonnes). This fully compresses the panels and gives them their high density. After this, the panels are cured in two ways, air-cured and autoclaved.



Air-Cured

Of the raw material used in air-cured fiber-cement, the greater part consists of the bonding agent Portland cement. In order to optimize this product’s properties, additional materials are added, such as powdered lime. Synthetic organic fibers, made from polyvinyl alcohol (PVA), are used as reinforcing fibers. These fibers are like those used in the textile industry to produce breathable waterproof garments, protective fabrics, and medical thread.

During the production process, fibers, such as cellulose, act as filter fibers, and air is also present in the form of microscopically sized pores. The mixture passes through the Hatschek process as explained above. Following the pressing stage, the panels are cured at ambient conditions for 28 days. This difficult process of mixing, forming, and curing results in the unique appearance of the EQUITONE [natura] panels, where the fibers of the material can be seen in the panel’s surface.

The industrially-applied, multiple hot-film surface guarantees the panels have a consistently high standard of quality. They are non-fading and UV-stable. A sealing coat of equally high quality is applied to the rear of each panel. Every panel produced is tested and certified as an environmentally compatible and healthy building material. The panel is also ready to receive alternative finishes such as high-quality paint and UV-hardened PU coating.

Autoclaved

Autoclaved fiber-cement is produced from four main raw ingredients: silica (sand), cement, cellulose and water. These materials are mixed together to create a slurry. Then, the mixture passes through the Hatschek process as explained above. Following the pressing stage, the stacks enter an industrial-size pressure cooker, known as an autoclave, and steam is added to the autoclave until the right temperature is reached. It then “cooks” for the required time.

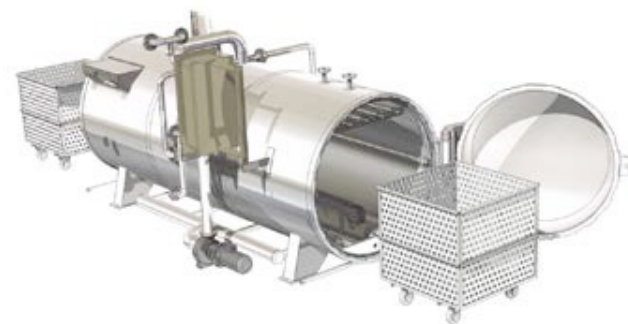

Once the boards emerge from the autoclave, they have attained much of their final strength. At this stage, these boards are ready for finishing, cutting, and other preparations needed for shipping to various market destinations.

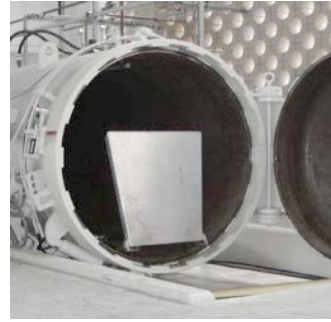

General

While there are differences in the manufacturing processes between autoclaved and air-cured panels, the end results are similar. There are some minor technical differences between all the panels, none of which makes one panel better than the other for use on ventilated façades.

The main difference between the panels is the final appearance. It is not possible to achieve the EQUITONE [natura] fibrous appearance with an autoclaved panel. The same goes for the EQUITONE [tectiva] panel as its unique natural finish is not possible with an air-cured panel.

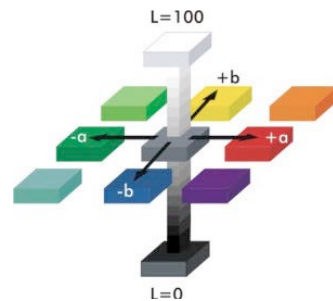

Color

Throughout the manufacturing process of the EQUITONE panels, the color of the panel is checked at regular intervals. If necessary, the process is adjusted to ensure the appearance of the panels is consistent. To define and describe the color and tonal variations, the internationally recognized Cielab color system is used. The panel's color can be determined by parameters a , b , and L .



The Cielab system consists of the two axes, “ a ” and “ b ”, which are at right angles to each other and define the hue. Axis “ a ” represents green to red. Axis “ b ” represents blue to yellow. The third axis indicates the brightness “ L ”. This is perpendicular to the “ a ”, “ b ” axis. Color variations are classified as ΔL , Δa , and Δb (Δ =delta).

Color differences between the panels cannot be entirely excluded from any façade. However, good on-site practice to reduce any risk of complaint would be to ensure all panels, on the same façade, are from the same batch, and the material is ordered within a reasonable time. Before fastening, any panels with obvious color variations should be set aside.

When viewing the panels, it is advised they are viewed from approximately 20 ft. (6.1 m) and from different angles. Color differences can be accentuated by the orientation of the panel, the viewing angle, and the effects of light and moisture.

For on-site color measurement, the device Spectro-guide, from Byk-Gardner GmbH, can be used.



Sustainability

Manufacturing

Each of the manufacturing plants is continuously working to make the process more environmentally sustainable. Some recent initiatives include the switch from heavy fuel to natural gas; sourcing lime and sand locally; using cellulose from fully renewable sources; changing the way raw materials are delivered (transport via the canal), introducing a new co-generation power unit which recovers the primary energy and reuses it; and aiming to have all hard factory waste recyclable. Both manufacturing plants operate in accordance with ISO 14001 Environmental Management System.

Green Building Assessments

While this area of having a building assessed for its energy and environmental design is still in its infancy, it is slowly becoming more popular. The goals of these schemes are to establish standards of measurement, promote good design practices, recognize environmental leadership in building industry, and increase the awareness among customers by specifying the benefits of a green building.

In the United States, the predominant Green Building Scheme is LEED, Leadership in Energy and Environmental Design, from the U.S. Green Building Council. Other internationally-recognized green building certification systems are BREEAM (British Research Establishment), DGNB (Germany), or HQE (France). These all promote sustainable building and development practices through a suite of rating systems.

One of the aims of these schemes is to encourage the use of materials with a lower impact on the environment, based on the full life cycle of the materials in question.

This is a complex part of the industry and is changing regularly. It is a minefield of competing commercial interests. The assessment itself is a very complex area and experts are becoming more common, especially with “signature” buildings. There are different building ratings between each scheme. Therefore, it is not possible to rate one scheme against another as they all use information differently. They also give a different loading to the main elements of the scheme. For example, the materials section presents 22% in the DGNB, 13% in BREEAM and 14% in LEED.

Environmental Product Declaration (EPD)

An Environmental Product Declaration (EPD) is a third party verified report of environmental impacts associated with the manufacture and life of a product. It includes a life cycle assessment of the product.



Life cycle assessment is the only method that assesses the environmental impacts of a product, or activity (a system of products), over its entire life cycle. It is, therefore, a holistic approach that considers:

- Extraction and treatment of raw materials
- Transport and distribution
- Educational tools
- Product manufacturing
- Product use
- End of life

The main goal of the life cycle assessment is to lessen the environmental impact of products and services by guiding the decision-making process. For companies, designers, and governments, life cycle assessment represents a decision-making aid tool for implementing sustainable development.

All EQUITONE panels are certified with an Environmental Product Declaration according to ISO 14025 or EN 15804. These EPD's are valuable as they can assist the designers and assessors in completing the Green Building Assessments.

BRE Green Guide

In the UK, the British Research Establishment, one of the world's most renowned research centers, has a "Green Guide to Specification", which contains a listing of building materials and components assessed in terms of their environmental impact across their entire life cycle, from cradle to grave, within comparable specifications. EQUITONE panels can achieve A+ rating when used in those constructions specified in the guide.

Recycling

A concern today is what happens to the material at the end of its life. How materials are disposed of is a growing environmental concern. One benefit of a fiber-cement, ventilated façade is the layers can be separated when the façade comes to the end of its life. This means the components, such as the fiber-cement, aluminum, timber, or insulation, can all be divided and sent for recycling separately. This is not possible with other materials or systems, like EIFS.

A new, revolutionary process has permitted most EQUITONE fiber-cement products not fit for distribution to be recycled back into the production as a raw material component. This lowers the CO₂ emissions and reduces energy consumption.

Long Life

The life expectancy of a fiber-cement ventilated façade has been confirmed, by the British Research Establishment in the UK, to be 50 years or more.

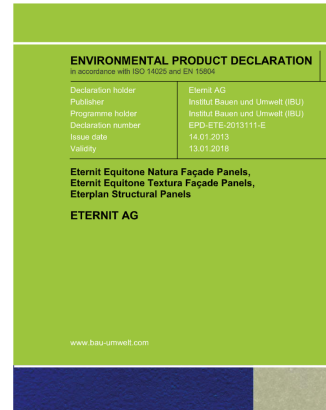

The History of the Ventilated Façade

Many people believe the ventilated façade concept is a new phenomenon. It was not a scientific breakthrough but a more gradual and intuitive discovery that occurred, centuries ago, in Norway. This approach was called the “open-jointed barn technique” since it was originally used in the construction of barns. The timber cladding had openings at the top and bottom of the timber to allow water drainage and the evaporation of any rain.

Scientific research of the underlying principles of a ventilated façade did not begin until the 1940’s. It was quickly recognized the principles involved in a ventilated façade were vastly superior to anything else in use, at the time, and still holds true today. Early research concluded it is unwise to allow walls made of brick, or concrete, to be exposed to heavy rain. The porous nature of the materials acts like blotting paper and absorbs water.

The Alcoa building in Pittsburgh, originally designed by the architect Harrison + Abramovitz, was one of the first, very large buildings to utilize modern rainscreen cladding. The 30-story building was built in 1952 and clad with large baffled aluminum panels. The baffling provided resistance to water penetration. Ventilation was provided in the airspace between the cladding and the main wall to dry any moisture.

By the late 1950’s, the British Research Station, and other organizations, began to highlight the advantages of having a ventilated airspace behind a wall. In the early 1960’s, the Norwegian Building Research Institute published the idea of equalizing the air pressure in a cavity, behind a rainscreen, with the outside air pressure. This concluded the rainscreen prevents the actual wall from becoming too wet. The terms “rainscreen principle” and “open rainscreen” were first used in 1963 by the National Research Council of Canada.



Research continued in the 1960's and 1970's with refinements being made principally in Canada and Europe. By the 1980's, the principles of rainscreen cladding were well understood. Today, the potential problems caused by global warming can be easily addressed with this building technique.

Etex Panel History

Belgium's Eternit NV started production of large-format, flat panels in the mid-1950's. The aim was to expand the possibilities for using larger panels which had, until then, been confined to industrial use. At the same time, efforts were made to improve the coloring techniques generally practiced during that era. Originally conceived for inside wall treatment, Glasal's fabrication process was improved during these early years. Firstly, the coating was upgraded for use on tables and other furniture, resisting scratches, acids, cigarette burns, etc. Next, and most importantly, the process was adapted, so the panel could be used as a vertical outdoor façade cladding.

Combining the qualities of the coating with those of the panel resulted in a product that gave the architects of the day a new material. Having a new material, ideal for the ventilated façade system, allowed the architects to be more creative with how buildings looked.

In 1971, Germany's Eternit AG started production of its own Glasal panels.

Over the years, millions of square meters of Glasal were sold worldwide. However, many other alternative materials, that could be painted, entered the market.

In 1990, the first air-cured panel, **EQUITONE [textura]** was introduced. In 1992, production of air-cured panels moved to Neubeckum. This ensured all necessary expertise resided in one location. Investment in new technology continued, and, in 1995, two new coating lines were added. The steady introduction of new fiber-cement panels continued since. In 2004, the new generation of **EQUITONE [natura]**, with its through-colored panels, launched.



Around this time, Eternit NV started to use its manufacturing knowledge to develop a new through-colored panel with a natural appearance. This development started with the EQUITONE [tectiva] panel.

In Neubeckum, in 2008, the UV coating line was operational, and EQUITONE [natura] PRO and EQUITONE [pictura] were introduced. This technology is unique and is not available anywhere else.

All of this further reinforces these two factories are at the forefront of fiber-cement technology.

The Ventilated Façade/Rainscreen

The Ventilated Façade/Rainscreen

The term ventilated façade is more commonly used in continental Europe while rainscreen is a more popular term in English speaking countries such as the UK, Canada, and the US.

For this manual, the term ventilated façade will be used to mean the complete system and term rainscreen as the external panel.

A ventilated façade is a kind of 2-stage construction, an inner structure with a protective outer layer skin, the rainscreen. This skin protects the structure against the elements. A ventilated façade is ideal for use in both new buildings and renovation projects.

The key features of a ventilated façade are:

- An outer skin of panels (rainscreen)
- An air gap or cavity
- An insulated substrate that controls air leakage

The rainscreen shields the substrate from direct rain. However, depending on the nature of the joints between panels, some water penetration may occur. The air gap and airtight substrate combine to limit this penetration. The cavity space can evaporate or drain the moisture away safely.

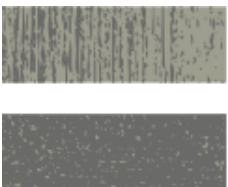
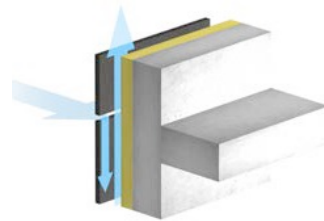
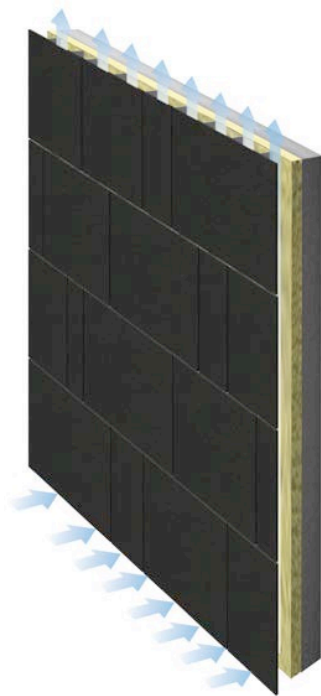

Drained and Ventilated Principle

Drained and ventilated systems are provided with openings providing drainage and ventilation. This combination allows air to circulate and dry the cavity between the inner and outer skins.

Placing the insulation on the outer face of the structure results in several benefits for the building:

- In cold weather, it keeps the building warm and the cold air is prevented from affecting the building structure
- In warm weather, the ventilated façade has a cooling effect when outside temperatures are higher
- Most of the sun's rays are reflected away from the building
- Heat passing through the panels is partially dissipated by the ventilating effect in the cavity
- Structural movement of the building is minimized

In conventional construction with internal insulation, the thermal shield has weak areas where the floor meets the wall. These are called thermal or cold bridges. This results in heat loss and can cause surface condensation. By having the insulation on the outer face of the wall, it can be easily mounted without interruptions; therefore, any thermal bridges are eliminated.

The ventilated façade system is very efficient in controlling condensation. Any risk of interstitial condensation occurs in the ventilated cavity. The breathable structure allows water vapor to pass from the inside into the ventilated cavity.

Acoustic performance of the wall is increased when compared to other forms of construction.

All of this results in a greater degree of comfort for the occupants and ensures a healthy building.

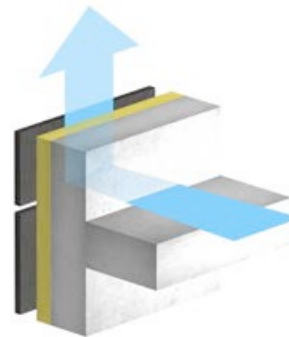
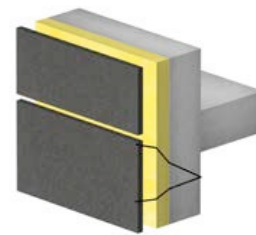
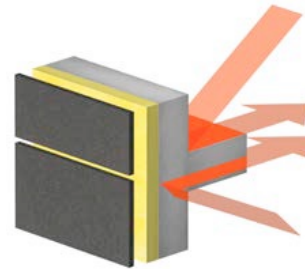
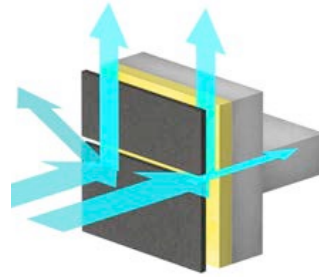

The concept of “the 4 D’s of weather tightness” is a simple way to explain a ventilated façade. This principle is gaining popularity:

- Deflection - Cladding with good detailing
- Drainage - Clear paths for water to escape
- Drying - Adequate spacing for ventilation
- Durability - Material should have a long life

D1: Check claddings and flashings for **deflection** (aim to keep water out)

D2: Arrange for **drainage** paths outside (should water get in)

D3: Arrange for ventilation and vapor diffusion **drying** (to eliminate remaining water)

D4: Choose **durable** components for conditions (to avoid damage while drying)

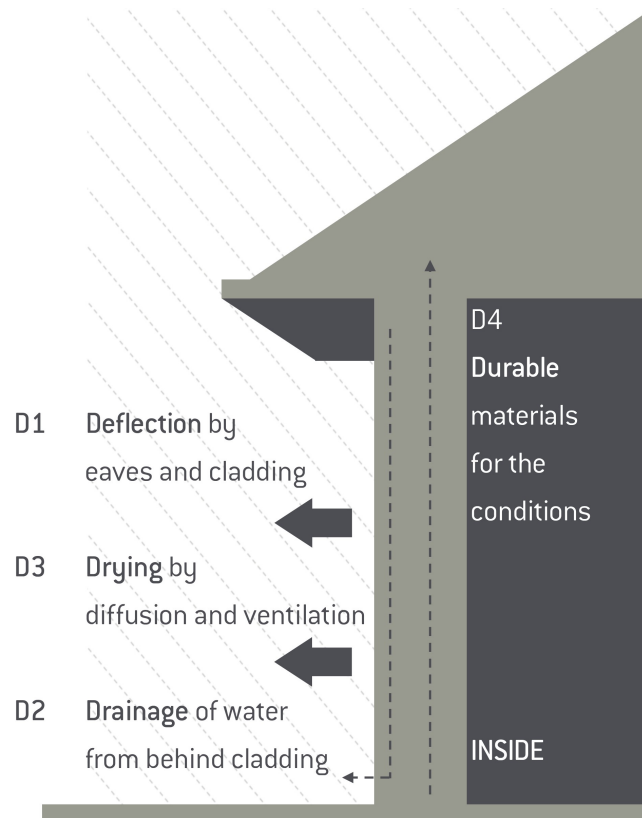

Site Work

Health & Safety

All EQUITONE panels have safety data sheets (SDS), which are compiled in accordance with 1907/2006/EG article 31. These OSHA documents outline any hazards associated with working with the panels and measures to minimize the associated risks.

Storage

All panel materials must be stored flat on pallets, indoors, and covered (in dry, climate-controlled conditions), protected from weather and other trades. Stack the pallets so the panels are ventilated. If moisture penetrates between the stored sheets, permanent surface staining in the form of efflorescence may occur. Condensation within the packaging can be an issue when the conditions are warm. The outer plastic protection may cause condensation if not removed after delivery.

Do not deliver any panels to site which cannot be immediately installed or unloaded into a suitable, well-protected storage area. Store products clear of the ground and on level bearers at a maximum of 2 ft. (600 mm) centers. Individual stacks can be 20 in. (500 mm) high, and not more than 5 stacks can be stacked on top of one another.

EQUITONE [natura], [natura pro], and [pictura] panels are supplied with protective paper, or foil, between the decorated faces. This protection should not be removed. Stack the panel's front face-to-front face or rear surface-to-rear surface. The panels should not be placed face-to-back.

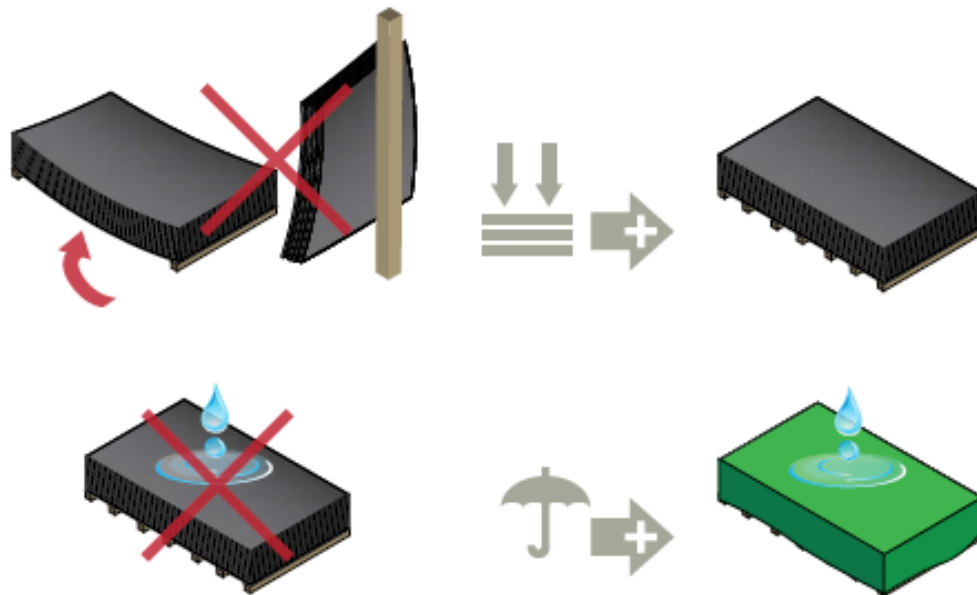

Handling

Always lift panels off each other; never slide them over one another, since scratching may occur. To carry the panels, carefully stand them on their side edge, and lift with two people (one person at each end) protecting the face from scratching or damage. Always lean panel towards back edge to avoid damaging visible front edge. Using soft



bearers can help to rest the panel edge on. Always carry the panels in a vertical orientation.

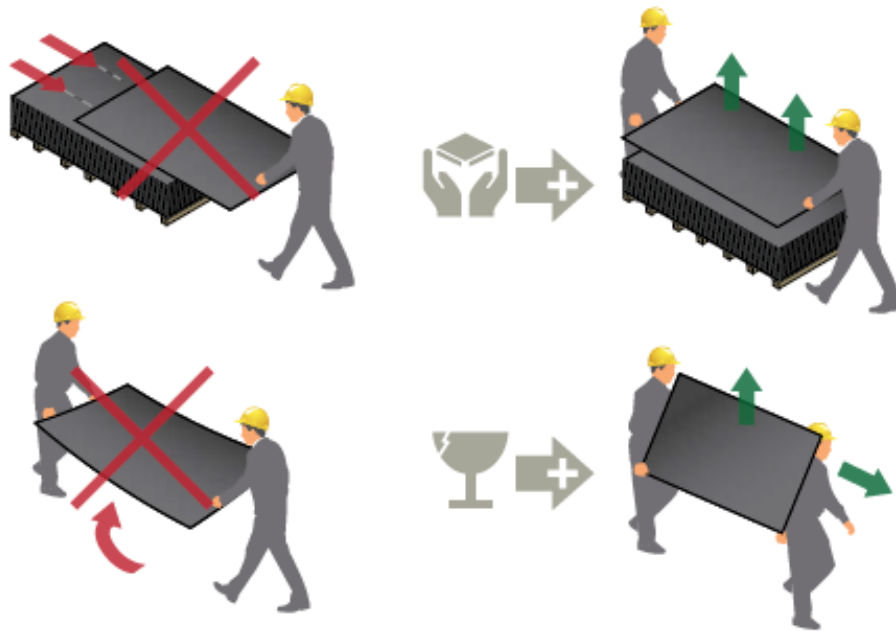

Transport

Moving panels stacked on pallets should be done with a forklift or a crane. Ensure the panels are secured to the pallet in a way that will not cause damage. Stacks should be transported under a waterproof cover.

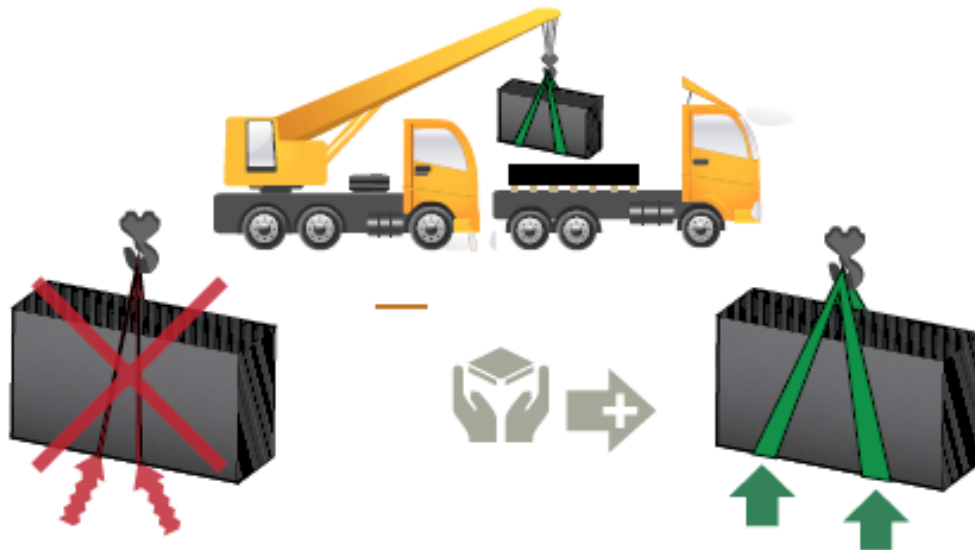

Tools & Accessories

Centralizing Tool

This tool fits any standard drilling machine and is used with all EQUITONE panels installed to a metal supporting frame using rivets. The use of this tool guarantees the smaller rivet hole (4.1 mm) is centered in the larger panel hole (11 mm). This guarantees the best allowance for support frame movement, caused by expansion and contraction.



The centralizing tool has a guide that neatly fits into the panel hole. When depressed, the tool extends the small drill bit to drill the metal rail.

This tool is available in several configurations to suit the panel, rivet size and type. It is recommended to remove any drilling debris prior to fastening rivets. The drill bit can be replaced.

Rivet Setting Tool

This highly-recommended tool fits onto the end of a rivet fastening tool and contours to the shape of the rivet head. This ensures the rivet fastening tool does not scratch the face of the panel when fastening the rivet.



Electronic Rivet Fastener

For fastening rivets, electronic/cordless rivet fasteners work best.

Drills, Bits, Saws & Blades



Drilling holes in the panels and railing can easily be performed using standard corded/cordless hand drills. Always drill into the face of the panels to prevent chipping/blowout. When using hand drills, full speed should always be used.

Drill bits used for drilling the panels should be hardened-steel bits. This ensures the longevity of the drill bits and quality of the drilled holes (no burrs, no burning). Available in 4.1 mm (rails), 7 mm (wood), and 11 mm (panels) diameters.



Saws, or handsaws, used to cut EQUITONE panels should be capable of 4000-6000 RPM. Ensure the direction of the blade rotation allows the leading edge of the blade to cut into the face of the panel. This prevents chipping of the panel face. Saws with guide rails and vacuum systems are highly recommended. Festo and Mafell brands are recommended.

Jigsaws are recommended for cutting irregular shapes, rounded corners, penetrations, etc. The pendulum function should be disabled. Bosch T141HM blades are recommended.

It is recommended saw blades be diamond-tipped and meant for use with high-density fiber-cement. Diamond blades should be used at 4000-6000 RPM (ff 15,000 linear feet of cutting). These blades are available in 6.3 in, 8.86 in and 11.81 in diameters.

As an alternative, Tungsten blades may be used at 1000 RPM with a much shorter life (~ 150 - 300 linear feet of cutting).

CNC Machines

There are many options for CNC machines, but it is recommended to use CNC machines equipped with vacuum extraction, for safety, and the capability to swap from drill bits to saw blades automatically. It is also best to have a CNC machine large enough to support two panels (adjacently). This allows for maximum fabrication efficiency; one panel is always being drilled/sawed, while the other panel is being removed/replaced. This ensures constant “work-in-progress.”

Milling Tool (for EQUITONE [linea] LT)



The EQUITONE [linea] LT milling tool is specifically designed to mill away the ridges, present on the face of EQUITONE [linea] LT, and subsequently drill the required 11 mm-hole through the panel. The depth of the milling is manually set. It is recommended holes fall in-line with the ridges for best visual effect. This tool should be used with



hand-drills only with full speed and minimum pressure.

Clamps/Suction Cups/Handles

Any clamps, suction cups, and/or handles used should not damage or soil the panel surface.

Spacers

Plastic spacers are recommended to assist with establishing/maintaining joint spacing around panels during install. Exercise caution when removing spacers to avoid scratching or chipping panel edges.

Support Rails

When fastening panels to railing, spare/scrap rails and clamps are recommended to assist with holding panels in place while fastening. When using the top-down-method, as described in EQUITONE's installation procedures, a support rail and clamps are extremely useful to support the weight of the panel during fastening.

Foam Tape

Adhesive foam tape is used to cushion the panels from the metal rails as well as moisture control. The outward force created by the foam also ensures the panels remain against the rivet heads. This acts as shock absorption in windy conditions and prevents water from soaking into the panels via wet rails. The foam tape also helps to prevent water from entering the façade cavity, through vertical hat channels, as the foam seals the openings between the panels and the rails.



Luko Sealant

Luko is a translucent, hydrophobic liquid applied to the edges of cut panels. Applying Luko seals the edges of the EQUITONE [natura] and EQUITONE [natura] PRO to prevent the absorption of water at the panel edges. This is often recognized as "framing" around the panel perimeter. This can lead to efflorescence staining which is usually permanent.



Luko is also available with an application kit including a tray, applicator, and applicator pads. Luko should be applied sparingly and any excess should be wiped away immediately.



Horizontal Joint Profiles

To baffle the horizontal joints, an aluminum profile is inserted behind the panels. These are non-structural and available in different options. Profiles can be anodized, powder-coated aluminum, or plastic. Horizontal joint profiles are typically used to prevent excess moisture from reaching the cavity, block trash/debris, and/or prevent pinching or catching of fingers/clothing. The horizontal joint profile is clamped between the panel and the railing. Aesthetically, it is best not to continue the profile across vertical joints. Cutting the profiles just short of the panel edge (~2mm) is recommended.

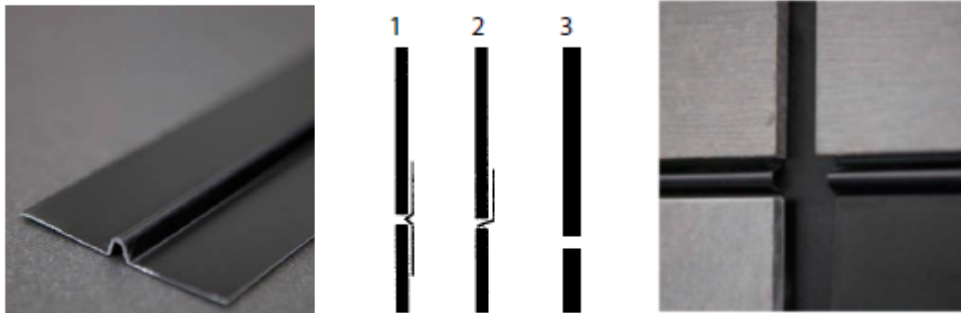

Corner Profiles

Corner profiles are available both as structural elements and non-structural elements. The structural versions support the panels, resist loads, and are normally part of the supporting frame. The non-structural versions are decorative and specialized companies provide many options. These can be anodized or powder-coated aluminum, galvanized steel, or plastic.

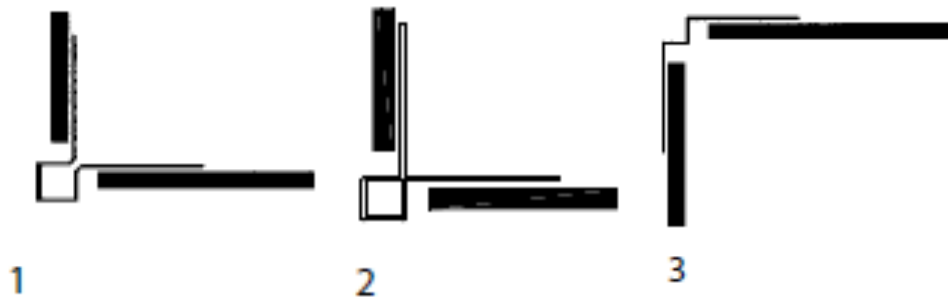

The profiles should be butt joints and should never overlap.

The corner profiles can be held in place via the panel fastening, however, if this is not possible, the profile can be fastened independently. Any such fastening must be flush with the profile and not cause the panel to distort.

The joints between all profiles must coincide with those of the railing.

Any corner profile must not be attached to two vertical rails across the expansion gaps. Attaching the profile across the gap will result in damage to the profile and panels.



Fasteners

EQUITONE Uni-Rivets

EQUITONE may be face-fastened to a metal supporting system (railing) using the EQUITONE Uni-Rivet. The rivets have color-matched heads to ensure a seamless look. The rivets are available in aluminum and stainless-steel options in various lengths to compensate for panel and rail thickness.

The installation and configuration of EQUITONE Uni-Rivets allows for proper panel movement as a result of expansion and contraction of the support system. Failure to comply with applicable EQUITONE fastening procedures may likely result in panel cracking.

All EQUITONE Uni-Rivets are provided with green, “GO/Gliding-Point” Sleeves. Red, or “STOP/Fixed-point” Sleeves are available separately and are required for every panel fastened to the façade. Applicable EQUITONE installation procedures should be referenced for details regarding use.

Aluminum supporting systems can be used with either aluminum or stainless-steel rivets. Stainless-steel or galvanized supporting systems may only be used with stainless-steel rivets.

Panel holes should be drilled using an 11 mm bit. Rail holes should be drilled using the centralizing tool with a 4.1 mm bit.



Uni-Rivet Sleeves

The red rivet sleeves are used to carry the weight of the panel and prevent rotation once installed to the railing system. The rivet sleeves simply slide onto the green rivet sleeves and set the rivet depth, or amount of in and movement of the panel between the underside of the rivet head and the surface of the rail. The panels should never be pinched against the railing which is likely to cause panel cracking. The rivet sleeves prevent this.

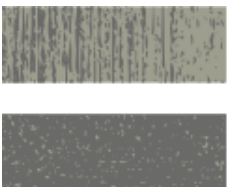

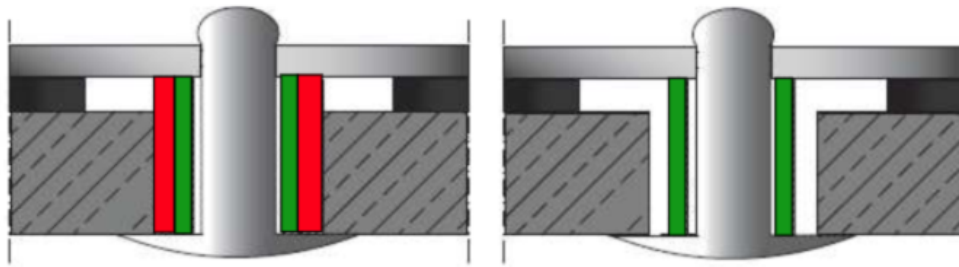

EQUITONE Uni-Screws

EQUITONE panels may be fastened to timber supporting frames using EQUITONE Uni-Screws only. Panels holes should be drilled using a 7 mm bit.



Uni-Screw Sleeves

Screw sleeves are used to protect the coating within the screw holes of the panels. For use with EQUITONE [natura] PRO and EQUITONE [pictura] fastened to timber supporting systems only.

Tergo+ (Concealed Fasteners)

Tergo+ is a fastening method used to conceal the fasteners to the rear-side of the panel. This method requires drilling an undercut hole and flaring the fastener inside the undercut hole to which a clip is affixed. The clips are used to hang onto a horizontal rail system.

Tergo+ systems require more fasteners than Uni-Rivet systems.

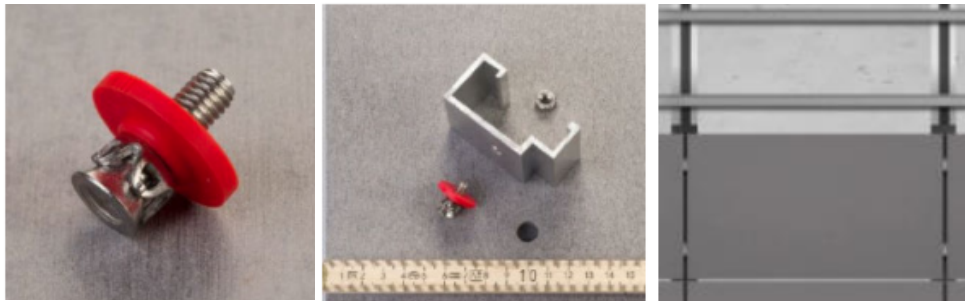

SFS Tuf-S (Concealed Fastener)

The Tuf-S concealed fastener from SFS is a more efficient approach to the previous methods of attaching EQUITONE cladding panels with regards to installation time, and ease of use. This method requires pre-drilling a hole using the SFS drill bit (pictured below), position the pre-drilled clip over the hole in the panel and push through the TUF-S concealed fastener. Remove mandrel using a GESIPA battery riveting tool combined with nose piece 17/36 or 17/40. The clips are used to hang onto a horizontal rail system.

Tuf-S requires two anchors per clip for EQUITONE panels. Drilling depths/embedment with vary depending on the EQUITONE panel being used.

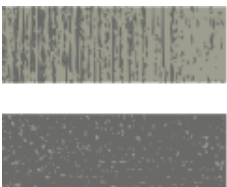
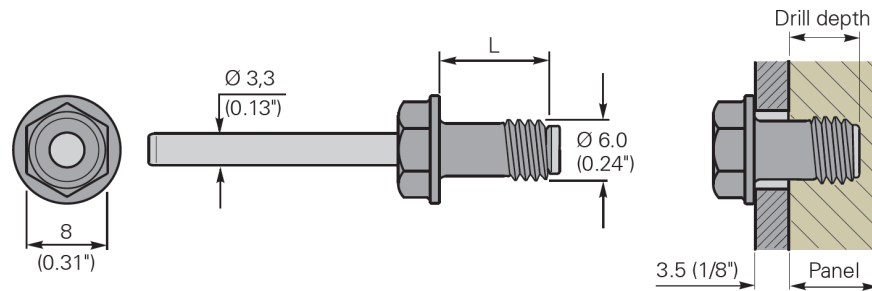

Panel Drilling

Panels should be drilled carefully using the specially designed EQUITONE fiber-cement drill bit. This drill bit is a fully hardened-steel bit with a cutting edge suitable for fiber-cement. This drill bit reduces the risk of sliding on the panel surface, provides a clean cut (no burrs or burning), and has a long life.

This illustration demonstrates the differences between a standard masonry bit and the EQUITONE drill bit. The masonry drill bit results in a fine dust, burning of the fiber-cement, and an elongated hole. The EQUITONE hardened-steel bit results in larger debris which is easier to clean from the panel's surface.

When drilling on the project site, a template for the hole position can be used to help speed up the process. This is helpful, especially for the corner holes. This template can be made up on-site, normally from metal. Ensure the template does not leave a mark on the face of the panel.

When drilling a panel, it is advised to place it on a solid workbench, preferably indoors or under cover. This will reduce the risk of staining as a result of drilling in damp/wet weather. Only one panel should be drilled at a time. Do not drill stacked panels. The panel should be held firmly in place to avoid vibration. Turn off the hammer-action function on the drill as this can cause the drill to move and slip.

Immediately after drilling, clean off all dust using dry methods. Follow up with wetted methods only if necessary.

Panel Cutting

As far as possible, panels should be pre-cut off-site. In situations where this is not possible (irregular site conditions), on-site working can be performed.

It is strongly recommended EQUITONE saw blades are used to cut the panels. These blades have been designed specifically for fiber-cement, and when correctly used, result in a high-quality finish. The blade is unique, with its minimal diamond tipped teeth, which are shaped to give a tear-free edge. Its vibration-dampening and has a composite-body construction.

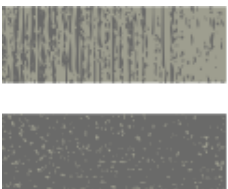
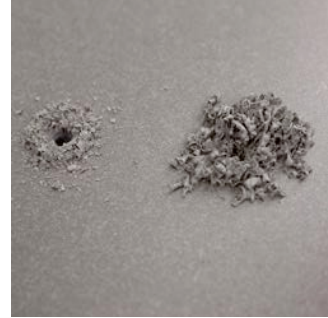

Blade Diameter	Blade Thickness	Borehole	# of Teeth	Saw Speed (RPM)
6-5/16" (160 mm)	1/8" (3.2 mm)	25/32" (20 mm)	4	4,000
7-15/32" (190 mm)	1/8" (3.2 mm)	25/32" (20 mm)	4	3,200
8-9/32" (225 mm)	1/8" (3.2 mm)	1-11/64" (30 mm)	6	2,800
11-13/16" (300 mm)	1/8" (3.2 mm)	1-11/64" (30 mm)	8	2,000

These blades can be used for upwards of 16,400 linear ft. (5,000 m) of cutting, assuming the correct procedures are observed.

The blade should be set to extend approximately 3/16 in (5 mm) below the panel to allow the debris material to escape.

For large amounts of cutting on-site, it is recommended a Festo AXT 50 LA, Mafell PSS 3100 SE Portable Panel Saw System, or equivalent, be used to cut the panels with an EQUITONE blade. Both saws have a guide rail which ensures the saw stays steady and gives straight cuts. These saws also have an enclosed blade, and vacuum system, to reduce dust and ensure good health and safety practices.

The EQUITONE panels should be oriented so the leading edge of the saw blade cuts into the face of the panels, which is normally face down. Therefore, it is important the workbench has a clean and soft material covering it to prevent scratching and marking of the panels.

As with the drilling process, when cutting the panels, it is advised to place the panel on a solid workbench, preferably indoors or covered. This will reduce the risk of staining as a result of cutting in damp/wet weather.

Only one panel should be cut at a time. Do not cut stacked panels. The panel should be held firmly in place to avoid vibration.

Where small amounts of cutting are required on-site, the quality of the cut edge depends on several factors including the type and shape of the saw blade and the height setting of the blade. An alternative to the recommended EQUITONE blade is a carbide-tipped, flat trapezoidal tooth/ negative blade with a tight angle of 5°. The number of teeth is related to the blade diameter where the distance between the teeth should not be smaller than 13/32 in (10 mm). To avoid vibration during cutting, the flange diameter must be 2/3 of the blade diameter. To prevent excessive chipping of the cut edge of the panel, the blade side-to-side movement should be equal to ± 0.1 mm. The depth of exposed saw blade, below the



panel, should be set to approximately 3/16 in (5 mm). This carbide-tipped blade will have a limited life and need regular replacing. As little as 165 linear ft. (50 m) of cutting can be obtained.

Due to the large number of variables, trial cutting on a waste piece of panel should be carried out to determine the optimum saw setting and speed of cutting.

Curved Cut-outs

For cut-outs or curved cuts, a jigsaw using a Bosch T141HM blade can be used. The jigsaw pendulum function should be disabled. The blade should also cut into the face of the panel, usually face down.



WARNING

Poorly maintained cutting tools, or incorrect saw speed/blade speed can result in localized heating/burning of the panel edges. Do not use grinder tools as they have a high cutting speed, which produces a higher than average pressure on the edges of the panels. They also produce excessive dust.



Edge Treatment

Sanding

It is advised to sand the edges of panels after cutting them to size. This reduces the possibility of damage and improves the appearance. A block of wood, approx. 16 in x 4 in (400 mm x 100 mm), with a piece of sandpaper (80-grit) affixed to it, can be used to lightly sand the edges.



Luko Sealant Application Procedure – for [natura]/[natura] PRO only

With semi-transparent coatings like those used on EQUITONE [natura] and EQUITONE [natura] PRO, moisture ingress at the panel edges can become apparent as a darker shade in wet weather. This effect will naturally disappear over time. The length of time depends on seasonal weather conditions.

To help prevent this phenomenon from occurring, the edges of all factory-cut EQUITONE [natura] and EQUITONE [natura] PRO panels are coated with Luko edge sealant at the factory. The edges of EQUITONE [natura] and EQUITONE [natura] PRO panels cut on-site must also be coated with Luko edge sealant.

Apply the Luko between +41°F and +77°F (+5°C and 25°C). Treat one panel at a time. Do not apply in wet conditions or after the panel has been installed.

1. Pour Luko into the tray
2. Using the sponge applicator, dip the sponge into the liquid, and remove any excess
3. Starting at one side of the panel, and while angling the applicator away from the face of the panel, run the applicator along the edge, ensuring full coverage
4. Using a micro-fiber cloth or paper towel, immediately wipe away any excess on the panel surface; otherwise, permanent staining is likely to occur
5. Repeat if necessary

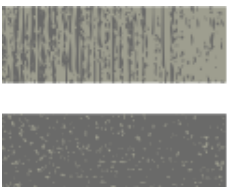

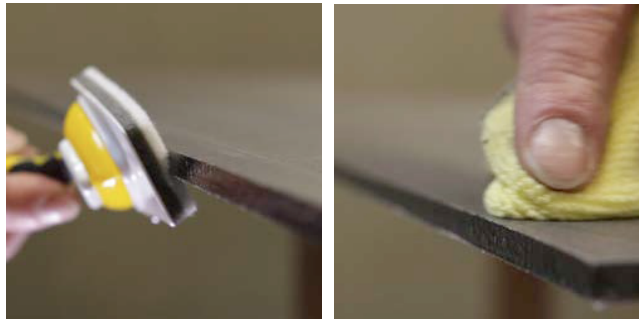

Cleaning & Maintenance

Introduction

Regarding cleaning EQUITONE panels, there are two types: mechanical cleaning and chemical cleaning. Mechanical cleaning includes the use of cleaning tools such as sponges, brushes, and cloths. Chemical cleaning involves the use of cleaning solutions such as diluted vinegar or other manufactured products/mixed solutions. Mechanical cleaning either can be completely dry or combined with chemical cleaning, while chemical cleaning is typically wetted.



When using mechanical methods, ensure the tools used are not extremely abrasive or scouring. This prevents scratching/fouling the surface of the panels.

When using chemical solutions, only those meant for use with fiber-cement, or gentle/natural cleansers, should be used. Always consult with EQUITONE prior to using any unlisted chemicals.

It is always best, and safest, to test any cleaning tool, method, or chemical on an inconspicuous area, or spare piece, to ensure desired results will be achieved. During the initial inspection/fabrication/installation process, panels will need to be cleaned individually as much as reasonably achievable. This minimizes the potential for problems during and after install. It is strongly recommended panels are not drilled after being installed on the façade as cement dust will spread over large areas.

When installation, or all construction, is completed, a final cleaning is recommended to remove any other construction-related residue.

When cleaning an entire façade, it is best to clean the entire façade, as opposed to single/separate panels, as color/tonal differences can occur from panel to panel.

New Panels

Shipping, handling, cutting, and/or drilling can generate dust. This dust contains cement that can permanently stain the surface of the panels if allowed to remain. Any moisture or humidity can essentially “re-cure” the cement dust resulting in extremely difficult, if not impossible, removal. When dry, and as early as possible, remove all dust from the



panel surface using dry methods first. Only proceed to wetted methods if dry methods are unsatisfactory/ineffective.

Step 1: Dry Methods (Mechanical)

- Micro-fiber cloth
- Compressed air
- Soft-bristle brush

Step 2: Wetted Methods (Chemical)

- Mildly acidic solution (diluted vinegar)
- Ammonia-free window cleaner
- Mild detergent
- Flush/clean with plenty of water

When dry cleaning is complete, proceed to wetted methods only if necessary. Should moisture contact any cement dust on the panel surface, immediately and thoroughly remove all dust with a brush/cloth and plenty of water. If wetted cement dust dries on the panel surface, varying degrees of efflorescence-staining may occur, as explained later in this document.

Wetted cleaning methods mostly apply to efflorescence or dirt and grease stains.

Air-Cured Panels

EQUITONE [natura]
EQUITONE [natura] PRO

EQUITONE [pictura]

For air-cured panels, start with dry cleaning methods, initially, to remove any excess dust/debris. Stains can be removed by normal washing with mild detergents or soap solutions and a sponge/cloth. The use of abrasive materials, such as steel wool or scrub pads, scourers, etc., is not permitted as these cleaning tools will leave irreparable scratches on the panel surface.

Autoclaved Panels²

EQUITONE [tectiva]

EQUITONE [linea] LT

For autoclaved panels, start with dry cleaning methods, initially, to remove any excess dust/debris. Any surface marks, stains and/or light scratches can be easily removed by normal washing with mild detergents or soap solutions and a sponge/cloth. More stubborn stains, marks, and/or scratches can be removed by lightly sanding the surface in the same direction as the factory grain pattern. Use no less than 80-grit sandpaper. Ensure all residual dust is thoroughly removed using dry cleaning methods. Follow with wetted cleaning methods if necessary.

² Sanding is allowed only for autoclaved panels.



Light Efflorescence

Small amounts of lime-scale and/or cement splashes, known as light efflorescence, can be removed with a 5% aqueous, malic acid solution like diluted vinegar. The mild solution should never be allowed to dry and must be washed off the panel surface, thoroughly and immediately, with plenty of water. The solution must also not contact the supporting frame as corrosion can occur.

When working with any acidic solutions, the user must be fully trained and experienced in its application, removal, and disposal. There is a risk the panel color or coating may become cloudy.

Heavy Efflorescence

For heavy efflorescence or stains, the only solution is to replace the panel as cleaning with severe chemicals will likely unsatisfactorily affect the appearance.

Inspections

All façades, regardless of the material used, should be inspected and, if necessary, serviced regularly. This avoids the unnecessary high costs of cleaning/repair in the long run. The building also will retain its attractive appearance much longer. If soil works into the materials for too long, it can penetrate so deeply simple cleaning is no longer effective.

The Soiling Process & Metal Cover Flashings

Dust, soot, oils, grease substances, etc., are present in the surrounding environment and can be deposited on the panel surface. If care is taken, through considerate design and application, local soiling and runs/streaks can be avoided. This can be accomplished via proper drip molding/flashing, proper sealing, and attention to prevent corrosion with metals such as zinc, copper, aluminum, steel, etc. The degree and speed at which materials become soiled largely depends on the characteristics of the material surface, chemical stability, hardness, porosity, and the ability to become electrostatically charged or not.

Graffiti

The UV-cured **EQUITONE [pictura]** and **EQUITONE [natura] PRO** surface coatings provide superior protection against common colors and spray paints. It is smooth and easy to clean.

Graffiti can be removed with dedicated graffiti removers, preferably those that use less harsh and/or environmentally-friendly chemicals. Cleaners with volatile solvents should not be used.

Note: When an on-site graffiti protection is applied, the appearance may change slightly as the protection affects the light reflectance of the panel's surface. As a result, the panel's color may appear different.

For aftermarket or do-it-yourself (DIY) graffiti-coatings, sacrificial, wax-based graffiti-protection is recommended. These coatings will likely require reapplication in periodic intervals, or when graffiti needs to be removed, and will result in the least amount of harm/influence to the panel's surface. There can be a slight difference in panel appearance when the coating is in place.

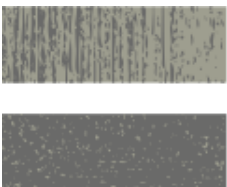

Note: EQUITONE [natura] PRO and EQUITONE [pictura] are the only panels equipped with built-in graffiti protection.

Pressure Washing

A pressure washer can be used, in extreme circumstances, to remove stubborn stains. This must be done by experienced users. Incorrect use can lead to removal of the panel's coating or additional staining.

Air-cured Panels³: A pressure rating of 290-430 psi (20-30 bar) is recommended. The nozzle must always remain a minimum of 2.5 in (60 cm) away from the panel surface.

Autoclaved Panels: A pressure washer, with clean water, at a maximum pressure of 1800 psi (125 bar), and a maximum flow rate of 2.65 gallons/min. (10 L/min.), can be used. The nozzle must always remain a minimum of 10 in (25 cm) away from the panel surface. The nozzle also must remain perpendicular to the panel surface.

Please contact EQUITONE with any issues not covered by this guide or for additional assistance.



Supporting Frame Design

EQUITONE panels are strong yet light, which reduces the amount of supporting frame needed (compared with other materials). Certification for the structural stability of any supporting frame should be in accordance with local building regulations and must be obtained by the building's owner or the owner's representatives, namely the project engineer.

Requirements

In any approval of structural stability, it is advised a minimum of 13/16 in (20 mm) be added to the planned cavity and insulation thickness between the wall and cladding, to allow for dimensional variations in the substrate. This amount may be changed if on-site measurements show the dimensional variation is less than this.

Whichever supporting frame is used, the wall should be checked by the installer, prior to installation, to confirm it is flat, level, and to ensure the correct fasteners and details are used. Any discrepancies should be directed to the design team.

Structural Design

All components of the external cladding must be designed according to the safety factors and permissible design load as stipulated in the local building codes/regulations. The load-bearing capacity of fastening systems and fasteners not covered by the building standards/regulations/approvals must be tested and certified in accordance with these local regulations.

Support Frame Layout

The most common, and recommended, arrangement for the panel's support is onto vertical metal profiles. Vertical profiles ensure the air flow in the cavity space is not disrupted, and there is free drainage of any moisture.

While fastening EQUITONE panels to a horizontal support frame is allowed, the designer needs to consider:

- Any moisture running down the back of the panel may become trapped and will rest on the horizontal profile; this may cause the profile to deteriorate over time or cause temporary staining on the panel
- The cavity between the insulation and the panel will be wider to accommodate the horizontal profile.
- The air in the cavity will not be as smooth flowing

Where possible, all structural connections should be facing "down-and-out" to minimize the risk of moisture travelling along them, back toward the wall.



Metal to Metal Corrosion

Care must be taken to avoid issues such as bimetallic corrosion when using dissimilar metals. In ventilated façades, there is always a risk of water being in contact with the metals. Therefore, this issue must be considered a risk, and the façade should be designed accordingly. For example, it is not advised to use aluminum rivets with a galvanized supporting frame as the risk of galvanic corrosion is high. Therefore, stainless-steel rivets should be used.



In severe marine environments, the use of uncoated aluminum or galvanized supporting frames will need to be substituted with an anodized aluminum or stainless-steel support frame.

Aluminum to Concrete

All uncoated aluminum components, in direct contact with cement surfaces such as fresh concrete walls, shall always be isolated with protective pads.

Timber and Metal

The risk of corrosion to brackets or fasteners, in contact with timber preservatives containing copper, mercury, or other incompatible compounds, should be avoided.

Anchoring

Whichever supporting frame is used, the secure anchoring of the frame back to the wall is very important. The design and selection of the anchor to suit the wall's substrate characteristics, and the wind load, should be based on engineering calculations together with on-site tests. This is important with renovation projects, especially when the performance of the wall is unknown. These calculations will determine the number of anchors required. A strong concrete substrate may result in fewer anchors than a hollow brick substrate. Consideration must be given to:

- Minimum pull out value per fastener should be at least 600 lb. (3kn or 300kg)
- The strength and condition of the new or existing structure
- The capability of the chosen anchor to accept the imposed live and dead loads
- Allowance of an adequate safety factor
- All anchors to be non-corrosive, such as stainless-steel

Many anchors are available, including the common frame screw with plastic plug, expanding bolts, or specialist chemical fasteners. Questions on anchors should be referred to reputable manufacturers.



Aluminum Support Frame

There are many manufacturers and suppliers of aluminum supporting frames. Each supplier will have its own design and recommendations on how best to use its products. However, the principles for this system are common, and the information given in this section is generic and offered as guidance. Most of the reputable suppliers of this type of framing will offer static calculations as well as the detail drawings as part of their overall service.

Aluminum is used because of its weight to strength ratio, its resistance to corrosion, and its easy workability. Another important characteristic of aluminum is it can expand and contract, depending on the surrounding temperature. For example, when using aluminum profiles with a length of approx. 10 ft. (3.05 m), an expansion of $\frac{1}{4}$ in (6 mm) must be considered for a temperature range of -4° F to 176° F (-20° C to 80° C).

Vertically oriented framing systems can either start with horizontal mounting rails, which are anchored to the substrate (studs), or with the vertical rails mounted directly to the studs.

Horizontally oriented framing systems can only begin with vertical mounting rails, which are anchored to the substrate (studs). Mounting the horizontal rails directly to the studs will not allow for enough cavity air flow.

Design considerations and project requirements will dictate which method is used. Either way, within the railing system, spacers should be used to ensure the exterior-most rails are as level as possible for mounting the EQUITONE panels.

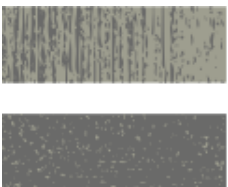

In the US, the rails used are usually “hat” and “Z” channels (rails). “Hat” channels are typically mounted where panel joints will exist. “Z” channels are used at the façade edges and all other intermediate locations. Other types of railing can be used if proper precautions are taken regarding corrosion, gauge of the metal, and configuration explained throughout this guide. “Hat” channels should be a minimum of 4 in. (100 mm) while 4-1/2 in. (115 mm) is recommended. This allows for tolerances and any setting out discrepancies. The panel fastener must be a minimum of 3/8 in. (10 mm) from the edge of the profile. Rails are available in various lengths. Some may even correspond with the height of the panels or multiple panels. It is best to consider this during design.

Aluminum rails should be 14-gauge. This allows for proper rivet fastening based on panel and rail thicknesses. Different lengths of rivets are available for various combined thicknesses.

The EQUITONE panels can be either rivet-fastened or fastened by means of the Tergo+ concealed method to an aluminum support frame.

Movement

The aluminum support frame system must be designed in a way that allows the material to expand and contract. This must happen without creating stresses in the structure or the panels. Therefore, to allow for this high level of material movement, a system of fixed points and gliding points is used. This system allows the framing system to expand and contract, without affecting the panels, by taking advantage of design characteristics of the EQUITONE Uni-Rivets and Tergo+ fasteners.

Because of the expansion and contraction characteristic of aluminum, it is vital joints between the rails coincide with the joints of the panels. A minimum 3/8 in. (20 mm) gap should be left between the rail joints. The joints between the rails should be at the same level around the building envelope.

No panel should be fastened to two different rails as the movement in the metal will cause the panel to crack.

Other Aluminum Systems

Systems to Reduce the Effect of Thermal Bridges

These systems use the principle of reducing the amount of metal-to-metal contact. The metal in contact with the thermostop is minimized. The bracket and its hanger piece are also separated with heavy duty plastic breakers.

EQUITONE may have designated or recommended manufacturers/suppliers of installation systems, but customers are not limited to any brand/manufacturer/supplier. When considering which type, proper precautions explained, in this guide, should be taken.



Galvanized Support Frame

Galvanized support frames are normally a locally-sourced product. The supplier or installer of this type of framing will be able to confirm the static calculations as well as provide the detail drawings. The following information is given as guidance and should be verified for each project by the project engineer.

One important point is the protective coating on the profiles is broken when any cutting, drilling, and/or possibly mounting happens on-site.

The EQUITONE panels can be rivet fastened only to this form of frame. Always use stainless-steel fasteners and components to reduce or eliminate corrosion associated with dissimilar metals (galvanic corrosion).

In the US, the rails used are usually “hat” and “Z” channels (rails). “Hat” channels are typically mounted where panel joints will exist. “Z” channels are used at the façade edges and all other intermediate locations. Other types of railing can be used if proper precautions are taken regarding corrosion, gauge of the metal, and configuration explained throughout this guide. “Hat” channels should be a minimum of 4 in. (100 mm) while 4-1/2 in. (115 mm) is recommended. This allows for tolerances and any setting out discrepancies. The panel fastener must be a minimum of 3/8 in. (10 mm) from the edge of the profile. Rails are available in various lengths. Some may even correspond with the height of the panels or multiple panels. It is best to consider this during design.

Profiles should be either 16- or 18-gauge steel, depending on the calculated load factors. This allows for proper rivet fastening based on panel and rail thicknesses. Different lengths of rivets are available for various combined thicknesses. In general, a minimum of G90, or greater, hot-dipped galvanized coating is recommended. However, this is conditional on location and climate.

Movement

The thermal expansion of galvanized-steel is not the same as aluminum. It is accepted that galvanized-steel has a thermal movement less than half experienced by aluminum. For example, a profile less than 13 ft. (4.0 m) long may not need any allowance for movement.

Therefore, it may be possible to simply use only fixed-point brackets. However, the principle of fixed and gliding points is a good one and, where possible, is recommended for all metal supporting frames. This is especially relevant in climates experiencing extreme variations in temperatures, day-to-day and/or season-to-season.

The joints between the profiles must also coincide with the horizontal joints between the panels. A minimum 3/4 in. (20 mm) gap should be left between the profiles. The joints in the profiles should be at the same levels around the building envelope. No panel should be fastened to two different profiles as the movement in the metal may cause the panel to crack. Different support frame arrangements are possible, which are shown here, but note the panel is never fastened to two separate profiles.

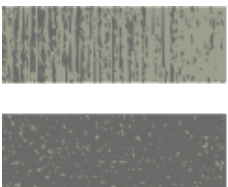

Metal Supporting Frame Details

Base Detail

Normally, the ends of the panels are best positioned above the finished ground level, a minimum 6 in. (153 mm). This will help prevent rain splash-back from the ground while maintaining enough space for the air to enter the cavity. No planting should be sowed near the air inlet as over time the plants may block the air inlets.

The space between the panels and the wall must have a perforated profile fitted. This piece allows air to enter the cavity space while preventing the entry of birds or vermin. Fasten the perforated profile to the wall and ensure it extends to within $\frac{3}{16}$ in. (5 mm) of the back of the panel. If the cladding panel is further away from the wall, a combination of profiles is advised. These must be fastened together.

It is recommended the panel overhangs the perforated profile between $\frac{3}{4}$ - 2 in. (19 - 50 mm) to form a drip to allow rainwater to fall away from the building. The bottom row of panel fasteners should be between $2\frac{3}{4}$ - 4 in. (70 - 102 mm) up from panel's bottom edge.

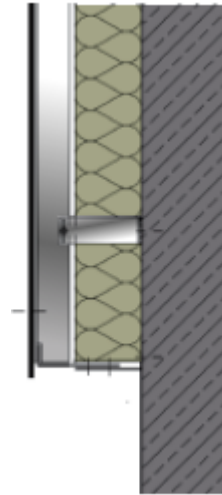

Window Sill

Air from the cavity must be allowed to exit under the metal sill. A minimum of a 3/8 in. (10 mm) gap should be left between the panel and the base of the sill. A perforated profile can be used for wider gaps to prevent entry of birds or vermin.

The front edge of the sill must be between 3/4 - 2 in. (19 - 50 mm) away from the face of the panel and offer adequate cover to the panels.

The sill should extend down over the panels by a minimum of 2 in. (50 mm).

The panel fasteners can be placed between 2 3/4 - 4 in. (70 - 102 mm) from the top edge of the panel.

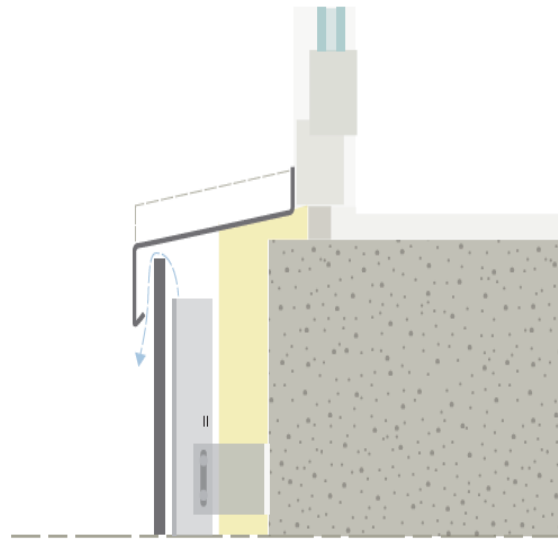

Window Head

Air must be allowed to enter the cavity above the heads of windows, doors, or other openings. A perforated profile can be used to protect the opening from the entry of birds or vermin.

For recessed window frames, a narrow strip of panel can be used as the reveal. For narrow reveals, flashings are best suited.

The panel can overhang the ends of the rails to form a drip by $\frac{3}{4}$ - 2 in. (19 - 50 mm). The panel fasteners should be between 2 $\frac{3}{4}$ - 4 in. (70 - 102 mm) up from bottom edge of the panel.

To help conceal the perforated profile, the installer can paint it black prior to fitting.

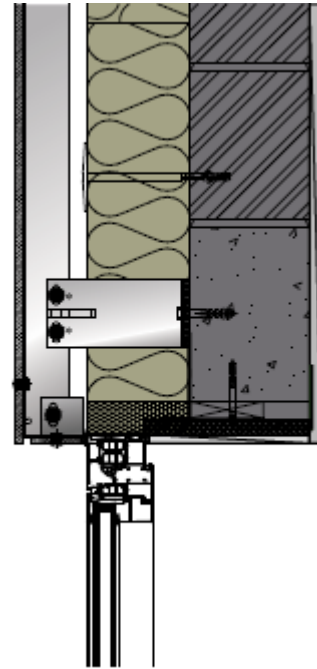

Window/Opening Jamb

The ends of the window sill must be returned up, behind the panel, or the flashing at the reveals, to offer protection from moisture ingress.

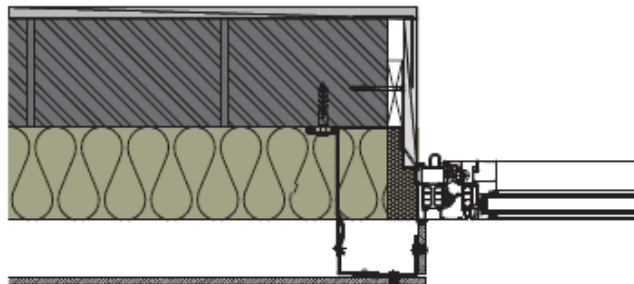

For recessed window frames, a narrow strip of panel can be used as the reveal. For wide reveals, an F-profile accessory can be fastened to the window frame to hold the end of panel secure. The front edge of the reveal panel can be fastened to the support frame corner profile.

For narrow reveals, specialist flashings are best suited. The fasteners can be positioned between 1-5/32 - 4 in. (30 - 100 mm) in from any side edge.



External Corner

External corners may be left as open joints or fitted with a proprietary trim profile.

Normally, for open joints, a 2 11/32 x 2 11/32 in. (60 x 60 mm) angle profile is used to support the panel edges. Where this angle cannot be fastened back to the wall, provide panel support within 14 in. (355 mm) of the corner. Joints in the corner profiles must coincide with the support frame expansion joints.

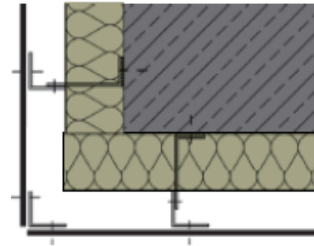

Some support frame suppliers have special structural corner profiles in their range.

Internal Corner

Internal corners may be left as open joints or fitted with a proprietary trim profile.

A 2 11/32 x 2 11/32 in. (60 x 60 mm) angle profile can be used to support the panel edges. As it is easier to fasten the main support frame to an internal corner, the open joint does not always need an angle bracket.

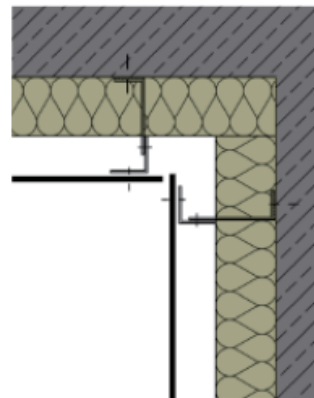

Expansion Joint

There is no special requirement for expansion joints with the panels as there is a gap on all sides and the fasteners allow for movement.

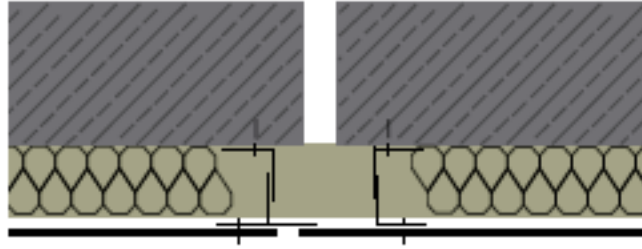

For building structural expansion joints, the panel must not be installed crossing over this expansion joint.

Coordinate vertical joints in façade panels with the position of the expansion/movement joint. An additional profile is used to support one of the panels. An adjustable “T” profile may be used, which allows the panel to slide.

Parapet

Air must be allowed to exit the cavity behind the parapet capping. A perforated profile can be used to prevent entry of birds or vermin.

A $\frac{3}{4}$ - 2 in. (19 – 50 mm) gap should be left between the face of the panel and the rear edge of the capping, depending on what height of wall that is vented.

The front edge of the capping must offer adequate cover to the panels and provide a minimum of 2 in. (50 mm) overhang protection.

The panel fasteners can be installed between 2 $\frac{3}{4}$ - 4 in. (70 – 102 mm) from the top edge of the panel.

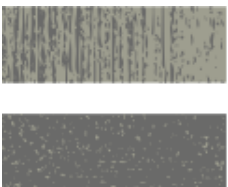
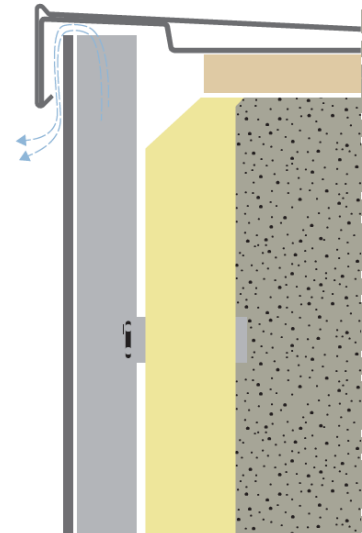

Design Considerations

Panel Layout

While the design of the supporting frame is calculated around the wind-loading the façade will be subjected to, another important point is the actual panel layout desired by the architect. The panel layout can have a big influence on the amount of large or small profiles needed.

For example, using the same size panel in a vertical pattern will result in a different supporting frame layout than if the panels were arranged horizontally. The vertical panel arrangement will use approximately a 50/50 split of large and small profiles while the same panel used with a horizontal arrangement will use only half as many large profiles and more small profiles; therefore, reducing the cost of the support framing.

Other influences on the supporting frame layout include having staggered panel joints, or total free patterns, which uses different panel sizes in a random layout. This could result in having to use all large profiles.

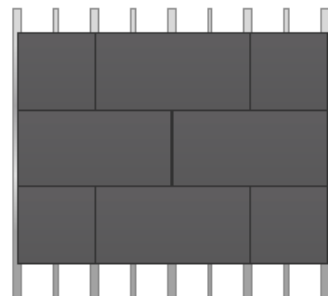
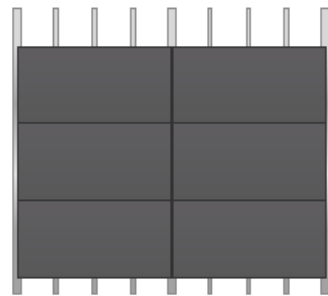
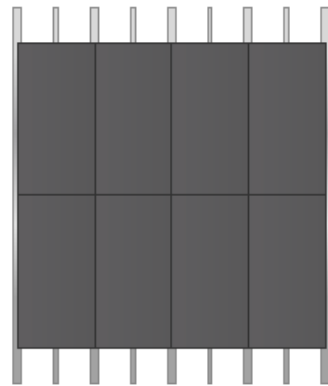
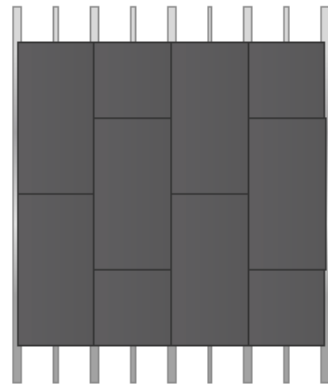

Cavity

The cavity is a primary feature of a ventilated façade. It is designed to act as a pressure cushion to prevent water from reaching the insulation or substrate. By ventilating the cavity, moisture arising from water passing the rainscreen, moisture migrating from the inner surface of the wall, or condensation will be removed by either evaporation or simply by running down the back of the panel and escaping out and away from the substrate.

It is generally considered the minimum cavity depth should be at least $\frac{3}{4}$ in. (20 mm), immediately behind the back of the rainscreen panel to the face of the insulation or substrate, whichever is first. However, in some countries, like the UK and Scandinavia, the regulations require a minimum of 1 in. (25 mm). Therefore, it is important each state adopts the local requirement.

This minimum depth is only suitable for low rise buildings up to 33 ft. (10 m) high. As the façade gets higher, the cavity needs to increase in depth:

Building Height	0 – 33 ft. (10 m)	33 – 66 ft. (10 – 20 m)	66 – 165 ft.* (20 – 50 m)
Minimum Cavity Depth	$\frac{3}{4}$ in. (20 mm)	1 in. (25 mm)	1-3/16 in. (30 mm)

*For heights >165 ft. (50 m), interpolation may be required to determine required cavity depth.

The type of joint used between the panels will also have an influence on the cavity depth. Open, horizontal joints will allow more air movement than baffled joints, and, therefore, a deeper cavity may be considered with baffled joints.

Tolerances

When designing the depth of the cavity, it is important to allow for a tolerance. Building irregularities, especially uneven substrates, insulation holders, and the supporting frame must never compromise the depth of the cavity. This is critical when a horizontal support frame is incorporated into the cavity space.

Ventilation

A through flow of air is achieved by utilising the stack-effect, in which a current of air enters at the base of the cladding and exits at the top. As well as cavities being ventilated at the top and bottom of the façade, it is also important air is allowed to enter and exit under and over openings such as windows.



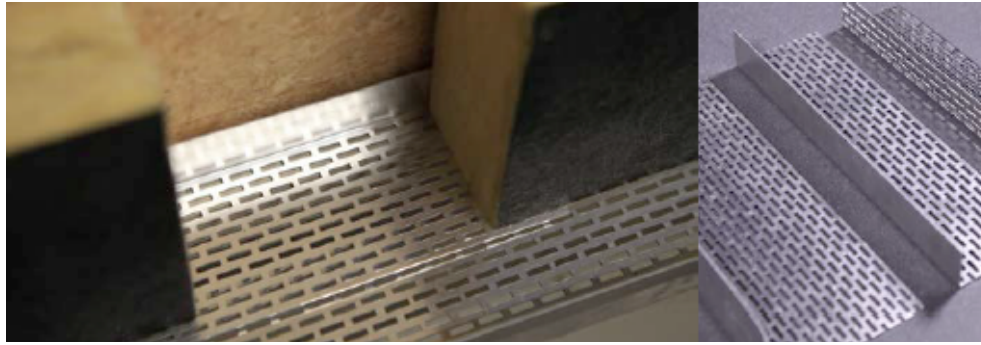

These openings need to be protected against entry of birds and vermin into the cavity space. Failure to protect from these creatures will cause damage to the insulation, cavity space and even the substrate. This is normally achieved by fitting a perforated profile. It is important the perforations are sized correctly to allow air in and out while stopping entry of small creatures.

It is recommended the equivalent of a 3/8 in. (20 mm) wide open gap is used to compensate for the perforated profile and building irregularities. As the building height increases above 66 ft. (50 m), this volume of air should also increase. The loss of free space, caused by using the perforated profile, should be considered by increasing the overall gap.

Joints

It is a feature of a ventilated facade the joints do not need to be sealed because the water penetration is managed by a combination of the cavity and the air tightness of the substrate. Normally three types of joints are used between the panels:

- Open joints in which there is a clear, open gap between the edges of adjoining panels
- Baffled joints where some component is used to block the direct line through the joint, while not sealing the joint
- Overlapped joints in which one panel overlaps the adjacent panel; shiplap is an example of this
- Sealed joints, where a gasket or wet applied sealant is used to make the joint water-tight and air-tight, is never allowed with EQUITONE panels

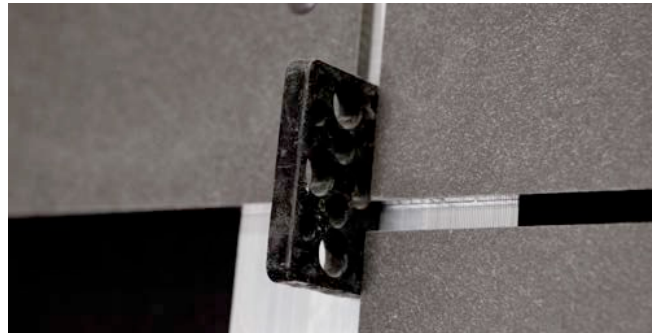

Joint Width

Many years of practice have shown the optimum width of the joints, between large panels, is 3/8 in. (10 mm).

Aesthetically, this joint width is best. It also offers the installer a level of tolerance when fitting the panel. The minimum permissible joint is 5/16 in. (8 mm) while the maximum would be 1/2" (12.7 mm).

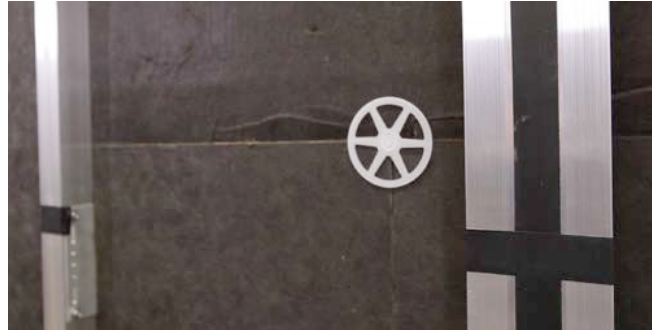

Vertical Joints

Vertical joints are mostly backed with a continuous profile ("hat" channel).

When a metal supporting frame is used, the gray or silver color can be prominent, especially when used with dark-



colored panels. This could be an unappealing feature. To eliminate this, the best solution is to use black-coated metal profiles, such as anodized aluminum. Alternatively, the visible areas can be painted, on-site, prior to fitting the panels. Another solution is to use a high-quality, external black tape. Ensure the profiles are prepped correctly before painting or taping as new metal profiles can have an oily residue/surface. Note, the painting or taping of the profiles on site will not endure as long as the anodized-metal profiles.



Horizontal Joints

Horizontal joints can be either left open or baffled. By leaving them open, the likelihood of dirt spoiling the façade reduces as the joint remains clean. The open joints also function as additional ventilation openings. An open joint also has the effect of reducing the wind-load on the façade panel. Therefore, it may be possible to reduce the number of fasteners.

Remember, the supporting frame is visible with open horizontal joints and may need to be hidden. Should it be required to baffle the horizontal joint, an aluminum joint profile is inserted behind the panels. Paint or tape also may be used.

By using a baffle, the majority of water is prevented from entering the cavity. Before final fastening of the lowest rivets or screws, the profile is slid up, under the panel. When the fasteners are attached/fastened, the profile is held in place.

Aesthetically, it is best not to continue the profile across the vertical joints but to cut it approximately $\frac{5}{32}$ in. (4 mm) narrower than the width of the panel, leaving the profile $\frac{5}{64}$ in. (2 mm) shorter at each side.

To prevent the joint profile moving sideways and showing at the vertical joints, cut and bend the top or bottom edge of the profile at both sides of one of the vertical support profiles or battens.

In some buildings, it is advisable to have baffled joints, such as the low areas of public or educational buildings. The baffles will prevent debris from being deposited behind the panels. In the case of kindergardens, the baffles will prevent small fingers from getting stuck in the joints.

When a building is of lightweight construction, some countries have a regulation insisting the joints be baffled to further reduce moisture ingress.

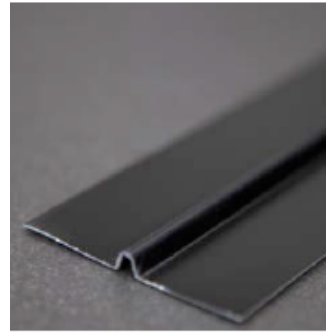

Edge Spacing

Before knowing how far from the panel edges to install rivets, it is important to understand why the limitations exist. When the outside temperature changes, the rails,

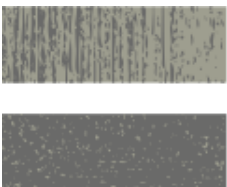

not the panels, expand and contract. The edge values exist to compensate for movement associated with this expansion and contraction. As the temperature changes, the metal responds accordingly: expands when heated, contracts when cooled.

We also know each panel consists of fixed-point and gliding-point rivets. The fixed-point rivets support the weight of the panel, while the gliding-point rivets allow for expansion and contraction of the railing. Each gliding-point rivet has 2.5mm of space, around the green sleeve, to allow for this movement.

Knowing this, as the metal expands or contracts, the space around these gliding-point rivets can be offset, or eliminated altogether, as the movement is cumulative from rivet to rivet. Another important point to note is the expansion or contraction occurs the most in the direction of the rail's orientation. For instance, vertical rails will expand in the up/down directions while horizontal rails will expand in the left/right directions. Assuming movement would originate from the fixed-point rivets and move out to the gliding-point rivets, any movement occurring would be compounded, with each successive rivet, until the edge of the panel is reached. This is where the edge spacing comes into play and why there are two different values listed.

The edge rivet spacing is configured to allow enough material to remain, at the edges, to prevent panel cracking/breakage under stress at the pressure point - the point at which the rivet presses against the panel. Knowing the rails mostly expand and contract in the direction of the rail orientation, the minimum edge space corresponding to the direction of the rail movement should be the larger of the two values in question, or in this case, 2-3/4". Therefore, for vertical rails, the edge space should be a minimum 2-3/4" between the edge rivet and the horizontal panel edge, and for horizontal rails, the edge space should be a minimum 2-3/4" between the edge rivet and the vertical edge of the panel. Again, this ensures enough material remains, in the direction of expansion or contraction, to prevent the panel from cracking/breaking. Here are illustrations showing the directions of expansion and contraction and the edge spacing values for each rail configuration:

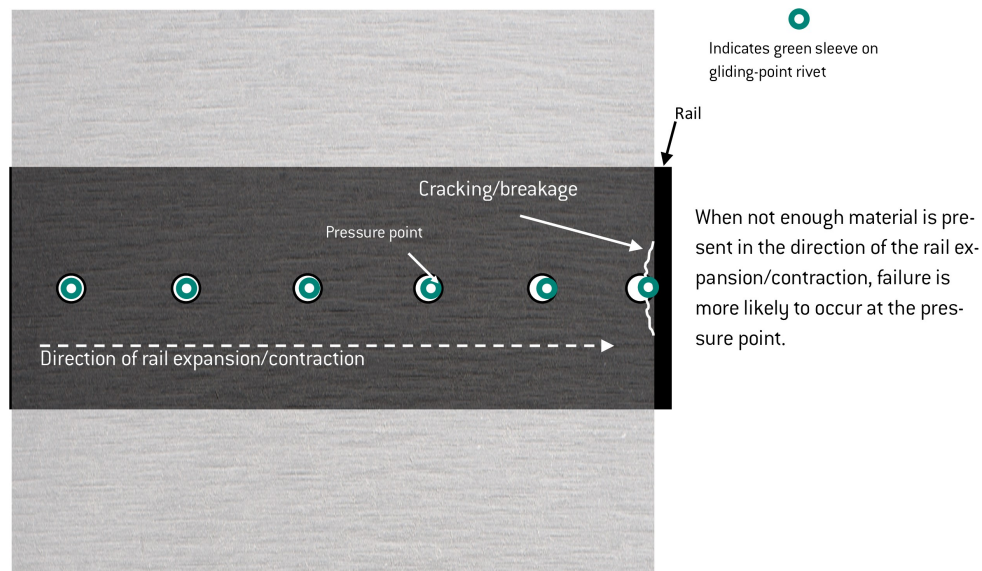

The above illustration shows how the gliding-point rivets can move, contact the panel, and potentially cause cracking/breakage as a result of the pressure exerted if less than 2 - 3/4" spacing was used. Having a minimum of 2 - 3/4" spacing from the edge rivet to the edge



of the panel should significantly reduce the likelihood of occurrence as there is enough material left to resist the pressure. Here is the edge spacing:

Corner fixings should never have equidistant fixing positions, this could result in cracking.

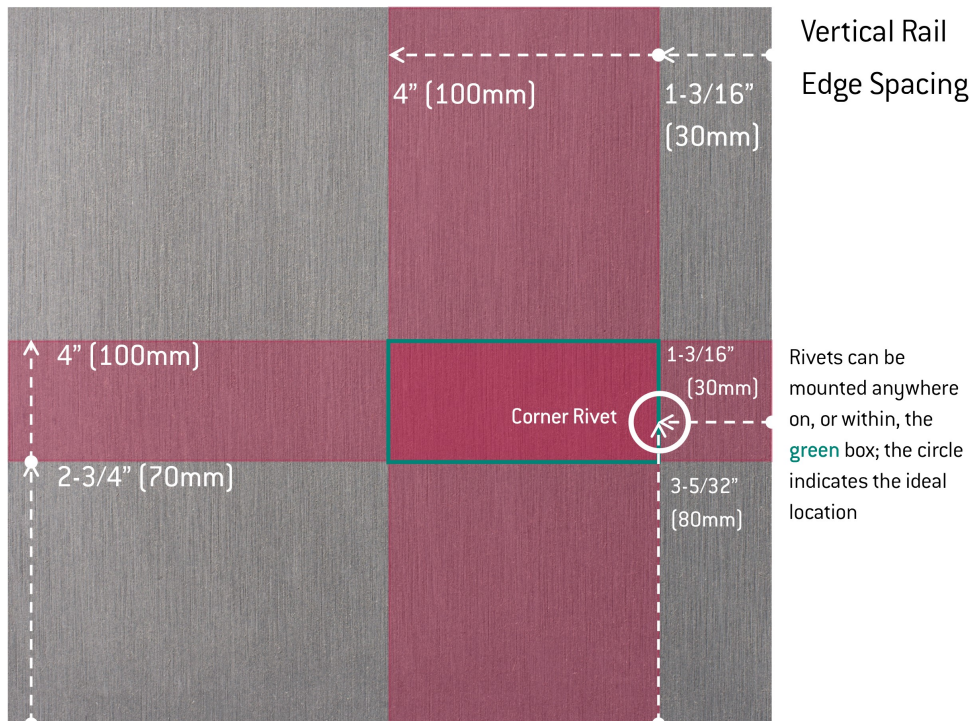

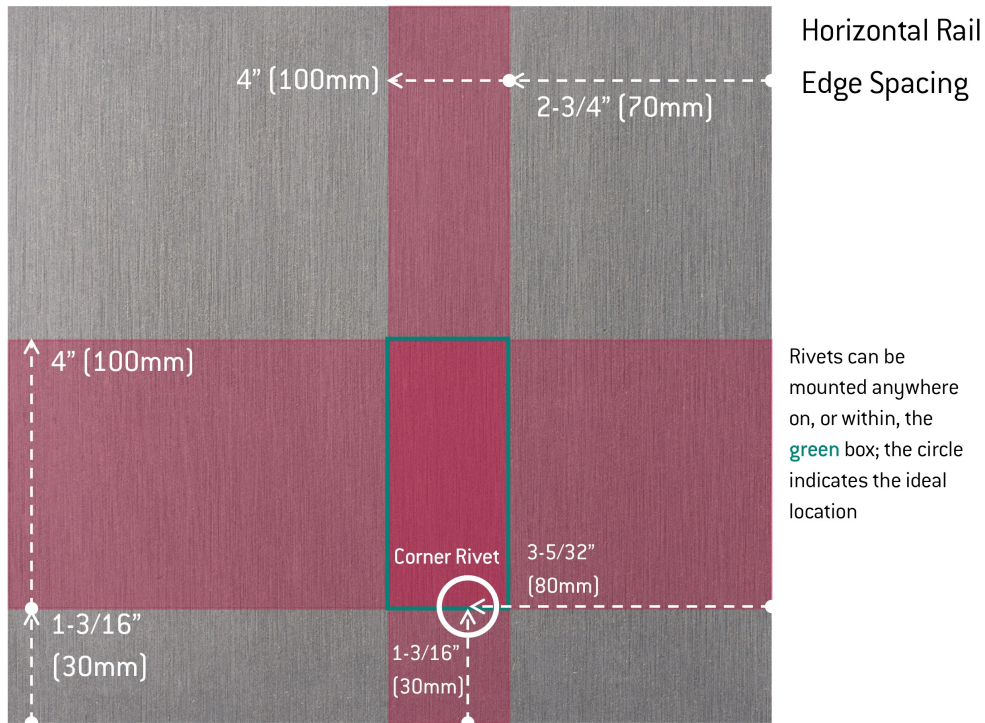

Walls

Structural Wall

The substrate is critical to the performance of a ventilated façade system. If air movement through the substrate is too great, the risk of water penetration is increased. Air leakage through the substrate also represents a path for energy loss and so must be limited.

It is important for the designer to consider what fastener will be used to secure the panel's support frame. Some of the wind loading is transmitted back to the substrate, and this should be considered.



Masonry Wall

Depending on the predominant local material, masonry walls can consist of clay, lightweight (cinder) block, concrete blocks or solid cast-in-place or precast concrete panels. The wall can either be a full, self-supporting, load bearing structure or an infill between floor beams and columns.

This type of wall may be existing or a new build. For renovation projects it is advisable the project engineer checks all masonry walls to ascertain whether the wall is sound and can support the added load. Many fastener suppliers will perform a pull-out test on a wall to confirm its capabilities.





Lightweight Wall

A lightweight structure of metal or timber studs is another form of substrate. This is commonly used as an infill wall between concrete floors. This type of wall may need special fasteners to hold the frame within the main building structure. It is also possible to construct complete structures.

The face of the frame requires an approved panel to act as an “air and water barrier”. The board may be required to offer some frame racking resistance or fire resistance and should be sized correctly. This sheathing must be air-tight. This can be achieved by using the correct sheathing board and taping the joints with suitable long lasting tape.

With this type of construction, the best way to affix the EQUITONE’s support framing should be considered. By fastening a horizontal rail over the sheathing and into the vertical studs, the designer has the freedom to place the EQUITONE panel vertical support profiles anywhere. Therefore, the EQUITONE panel support profiles do not have to coincide with the structure studs. The space formed by these horizontal rails, or battens, can be utilized with the insertion of extra insulation.

Floor-to-Floor or Frame Wall

In this construction, the rainscreen supporting framework is fastened to the primary structural elements such as the concrete floors. The framework needs to be designed to span the floor-to-floor height. The connectors, or angle brackets, fastened to the ends of the floors are specially designed by the supporting frame supplier. Note, depending on the wind-load, the vertical support profile thickness will need to be increased to safely span between the floors. This system normally involves the construction of a separate inner wall.

Windows and Doors

Whether the main structural wall is a timber/metal lightweight frame or a massive masonry construction, the wall should be air-tight, especially around openings such as windows or doors.

Air-tightness prevents moisture ingress and ensures the building remains thermally efficient. Install the windows or doors to the substrate and seal the edges with appropriate materials to reduce the risk of any moisture ingress.

Movement Joints

The term “movement joint” or “expansion joint” refers to the isolation joints provided within a building to permit the separate segments of the structural frame to expand and contract in response to temperature changes without adversely affecting the building’s structural integrity. In simple terms, they relieve any stress on the structure. Failure to incorporate these movement joint gaps into the structure will result in cracking under the stress.

The size and location of any movement joint is related to the choice of structural building materials and local climate. The ventilated façade has built-in movement joints utilizing a combination of fixed and gliding points. However, the main building movement joints must be continued through the rainscreen. The ventilated façade cladding should not be fastened to both sides of the structural movement joint.





Insulation

Insulation not only prevents heat loss from a building, saving on energy costs, but, in warmer countries, it also can prevent the building from gaining heat and can help reduce the energy needed for air-conditioning.

R-Value

The R-value is a measure of thermal resistance used with building materials. The higher this value the better the insulation's effectiveness. R-values are expressed as $\text{ft}^2\text{-}^\circ\text{F-h/Btu}$ and are normally cited without the units, for example R-3.2.

Ideally, the insulation should be rigid, fireproof, water resistant and breathable. To meet these criteria, several insulation suppliers have a proprietary board for rainscreen or ventilated façades. Each one has its own characteristics and level of performance. Those insulations that are suitable can be broken down and classified as mineral fiber or foam-based.

A few insulation boards to consider are:

Mineral Fiber



Polyurethane (PUR, PIR)

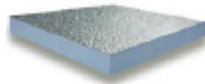

Phenolic Foam

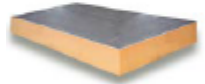

Cellular glass



Comparison of Insulation Types

As well as the cost differences between the insulation boards, other factors such as fire resistance, condition of the substrate, and ease of use amongst others should also be considered when specifying the board.

One way to consider insulation and its properties is to compare thicknesses. For a typical wall, the R-value of the insulation is most important as this determines the thickness of insulation needed. Therefore, a higher R-value-rated insulation allows for thinner insulation to be used when compared to lower R-value insulations.

Securing the Insulation

It is important the insulation is securely fastened in place and remains for the lifetime of the façade. If the insulation moves or falls away from the wall, there is a risk the cavity will become partially or completely blocked, therefore eliminating the benefits of the ventilated façade. In addition to the heat loss or gain that would occur via these

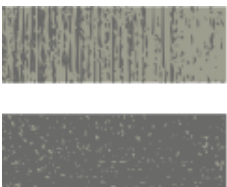

gaps, there is also an increased risk of condensation and mold growth. It is also important the insulation has no gaps at its joints and fits tightly around the supporting frame to reduce heat loss and the effect of thermal bridging.

Each insulation manufacturer has their own requirements for fastening their insulation boards. An alternative to mechanical fastening is the use of special adhesives. It may be required there is a minimum of one fastener per board that is a non-combustible type. This will prevent detachment of the insulation in the event of a fire and reduce the risk of damage to the structure.



Thermal Bridge

In a building, areas such as where the floor meets the external wall or where an internal wall meets the external wall, can result in the phenomenon of thermal bridging. However, by placing the insulation on the outside of the external wall this phenomenon is eliminated. This is one of the main benefits ventilated façades bring to the building.

Another form of thermal bridging can also be created when materials that are poor thermal insulators contact each other, allowing heat to flow through the path of least resistance. Thermal bridging is not only the loss of heat from the inside of a building but is also the gaining of heat from the outside particularly in warm countries.

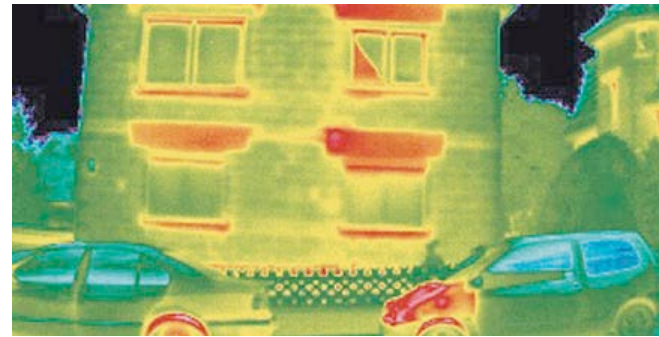

Ventilated façade supporting frames requiring metal brackets which penetrate the insulation layer can lead to thermal bridges; however, this can be reduced by suitable bracket design. Adding extra insulation around a bridge offers only a little assistance in preventing heat loss or gain due to thermal bridging.

The most common solution used today is to place a “thermostop” between the metal angle bracket and the substrate. This thermostop is a piece of rigid, strong PVC which is predrilled to suit the angle bracket. It breaks the bridge, therefore preventing the passage of heat. This is illustrated in the thermal modelling pictures below. The blue and green areas show the higher heat loss while the yellow areas perform better.

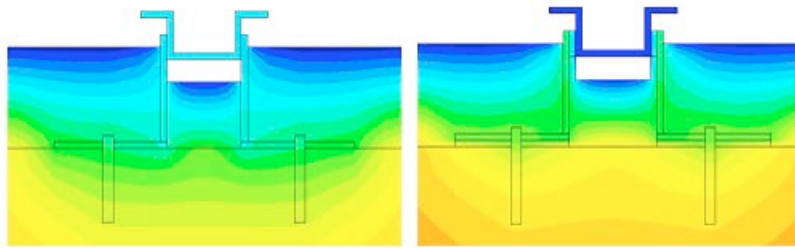
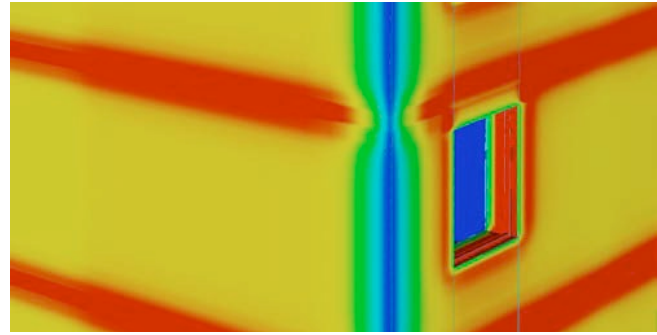

Temperature distribution of aluminum bracket without (left) and with (right) a thermostop (thermal separator)

While these thermostops are more than adequate for today’s requirements, insulation and supporting frame manufacturers are altering their designs and developing new ways to reduce or even eliminate the heat loss or gain.

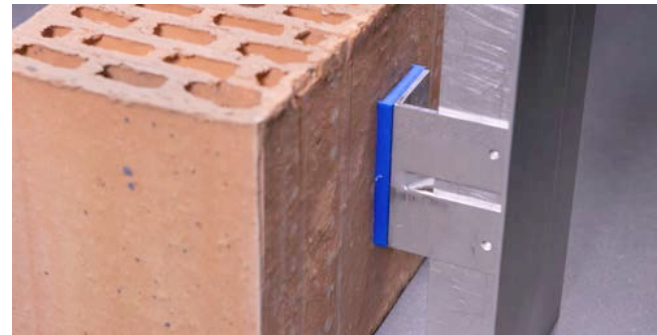

Wind

Wind load is one of the factors caused by climatic conditions, which has a variable effect on buildings. Firstly, the building location will be considered and then the building design.

Building Location

The key factors influencing the extent of the wind load are those of the location with the local wind climate and topography. The wind climate is recorded in the local codes using a wind zone map, which provides a time-weighted, average wind speed for various geographic regions. The topography and nature of the site surrounding the building location are provided in the standards through the terrain categories.



Effects of Terrain or Topography

Terrain has a strong influence on local wind speeds. Wind blowing over smooth terrain, such as grass or water, will maintain its strength and have little turbulence. As the wind blows over rougher terrain, such as towns and cities, the wind speed is reduced due to the frictional drag at the surface but, at the same time, the turbulence in the wind increases.

Proximity to the Sea

Wind and driving rain can increase the closer the building is to the coast. Another consideration the designer needs to address is the choice of materials. Not all materials are suitable for use next to the sea. For example, it is advised to use stainless steel fasteners instead of aluminum.

Building Design - Design for Wind Loading

During the design process, the engineer will refer to standards and regulations to design the integrity of the façade. This is then used to calculate the effective wind speed and dynamic wind pressure on the building envelope, by applying a series of factors to account for terrain, topography, building height and length etc. The spacing of the façade's supporting frame is determined by calculation once the wind forces on the structure have been determined. This is normally carried out by the support frame supplier and then approved by the engineer.

Wind Flow Around Buildings

All buildings obstruct the free flow of the wind, causing it to be deflected and accelerated, resulting in complex flow patterns. When wind strikes a building, it will give rise to pushing, or positive pressures, on the windward face and suction, or negative pressures, on the sides and leeward face of the building. The negative pressures on the side walls will generally be greater at the front end and reduce further back along the building towards the rear. This means the wind is trying to pull the panels off the wall. This is known as "wind-loading".

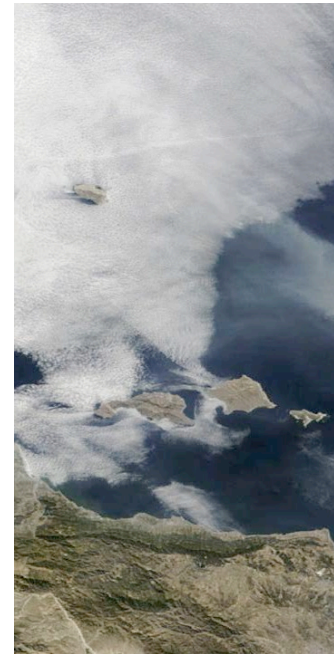

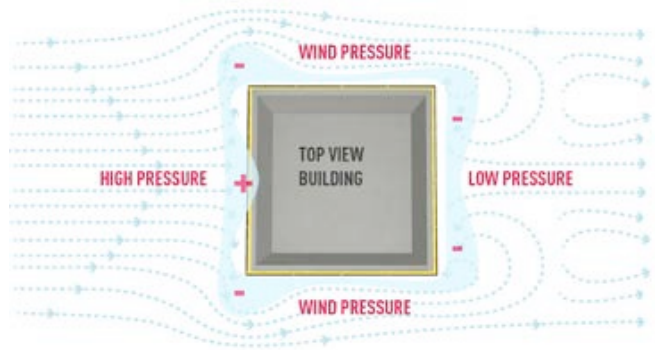

Façade Design

Where open joints are used between the cladding panels, a proportion of the external wind pressure can leak through the cladding to act directly on the building wall, relieving the loads on the cladding.

External Corners

External corners are one of the most vulnerable areas to wind. As well as the wind pulling the panel from the outside, the back of the panel can be also subjected to pushing from the cavity. To counteract this, a continuous vertical cavity closer can be introduced so the wind pressures are separated. Another solution is to use additional fasteners and install extra supports on both sides of the corners of the façade.

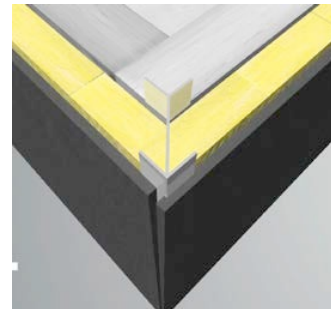

Building Shape

The shape of the building influences how the wind pressures are distributed. Recesses, overhanging areas, roof gardens and terraces will have a local effect on wind pressures.

Effects of Building Height

Wind speed increases with height above ground, it follows, therefore, the taller the building the greater the wind speeds acting on it. Of course, if the building is surrounded by similar tall buildings, the wind effect may not be as great. A low-rise building on an open flat site may have as many design considerations as a tall building.

Interaction Between Buildings

Should a tall building have a lower building upwind from it, then, depending on their relative dimensions and separation distance, the ground level wind speeds in front of the tall building can be magnified. Where a tall building is surrounded by closely spaced low-rise buildings, the windward vortex can still cause high wind speeds around the lower building.

Funneling

Wind funneling and flow acceleration can occur when there are gaps between the buildings. The distance between the building façades is a factor in determining the increased speed and pressure.



Aircraft vortices

Cladding near airports can experience higher local wind load forces due to air vortices being created by certain aircraft when taking off and landing, which may be greater than the normal.



Special Applications

General

While EQUITONE panels are used as a façade cladding, they can also be used in other applications. Here we describe some of these applications and more detailed information is available.

Balcony

For balcony panels, EQUITONE [textura] is available in 3/8" (10 mm) thickness. The panel is coated on both sides. It is possible to have each side in a different color. In addition to use as balcony panels, EQUITONE [textura] Balcony can also be used as divider screens between the apartments' balconies.

The maximum panel size is 122-3/64" x 59-1/16" (3100 x 1500 mm). This size is also known as 4 x 10 in the US.



Each state may have its own regulations and requirements for balcony panels which include fire and structural stability. The height of the barrier, the force this barrier needs to resist and the maximum opening size around the panel must always be considered.

The EQUITONE [textura] Balcony panel can be incorporated into prefabricated railing systems, fastened to metal frames with rivets or fastened with clamps.

How the railings are anchored should be confirmed by the designer. All balcony railings should be anchored with the appropriate stainless-steel anchors. The anchors can be positioned on the top, front face or underside of the balcony slab.

It is recommended 3/8" - (10 mm-) wide open joints are used between adjoining balcony panels and where the panel meets a wall. This will accommodate any panel or frame movement.

Curved Wall

EQUITONE panels are flat. However, it is possible to ease them around a curved façade. Note, the orientation of the panel is also critical. The longer a panel is perpendicular to its bending axis, the easier it will bend.

The minimum radius a 5/16" (8 mm) EQUITONE panel can be rivet-fastened to a curving façade is 40' (12.2 m). It is only possible to use the invisible fastening solutions on slow gentle curves with large radii.

When the panels are applied on a curved façade, the joint will not be square but is angled to accommodate the curve. Visually it is better to keep the outer edge of the joint gap at 3/8" (10 mm) and allow the inner edge to be less than 3/8" (10 mm). If not, depending on the curve, the joint could in excess of 1/2" (12.7 mm) wide. To allow this to happen, it is important the setting out of the support frame reflects this. The opposite applies to an inner curving façade.

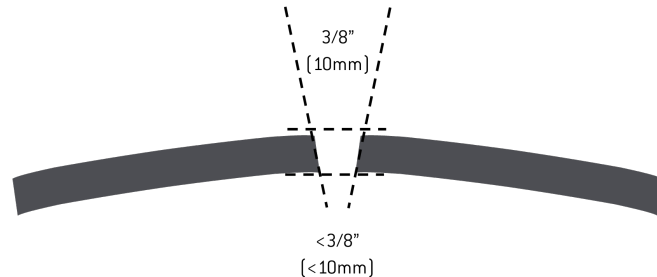

System Roof

EQUITONE [textura] and EQUITONE [pictura] panels can be considered for applications on a roof. Please bear in mind the panel is only decorative, and there must be a suitably designed water-proof construction under the panels.

Some important notes to remember when using the panels on a roof are:

- Roof pitch of $\geq 25^\circ$
- Maximum height above sea-level is 3,900' (1,200 m)
- Maximum wind load is 1,500pa (1.5 kN/m²)

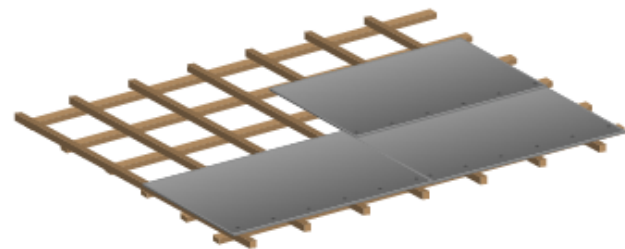

- Air must be allowed to move freely under the panels
- The panels are fastened to their own support frame which in turn needs to be secured to the roof structure
- All panels are to be overlapped horizontally by between 4" - 8" (102 - 204 mm) depending on pitch
- The vertical joint between the panels, which is open, is protected with a hidden flashing

The panels are normally fastened to timber battens with stainless steel screws with a rubber seal (black) gasket. The panel is predrilled with 5/16" - (8 mm-) diameter holes. For most locations, the panels need only to be fastened along their lower edge, just above the top of the underlying panel.

The designer needs to consider the detailing of penetrations, skylights, extractor pipes, chimneys, etc. and how both the waterproof under-roof and the panel are flashed. Ideally, services or penetrations needing to pass through the panels should have their lower edge located close to the horizontal overlap.

Holes in the Panel

It is possible to have holes drilled in the panel. Some simple rules apply to ensure the panel remains fit for purpose.

For hole diameters 3/8" – 1-3/16" (10 – 30 mm), leave a minimum of 4" (102 mm) around all edges of the panel. The minimum center to center dimension between the holes is 3-5/32" (80 mm).

A minimum of 3-5/32" (80 mm) should be left free from any holes around any fastener location.

In addition to the use of round holes, it is also possible to have slotted panels. The maximum size of the slot is 1-3/16" (30 mm). A minimum dimension of 2-3/8" (60 mm) should remain between the slots. Leave a minimum of 4" (102 mm) around all edges of the panel and between the ends of the slots.

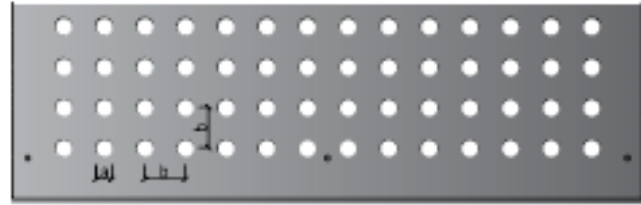

Curtain Wall

The post-and-beam or stick system, which is normally assembled on site, is the most common form of curtain walling and is used on low to mid rise buildings. The vertical members are fastened to the floor slab and then connected with horizontal transoms. Into this frame will fit the glazing or panels. Solid or colored panels are normally used to hide the ends of the floor slab or the ends of the partitions. EQUITONE panels can be used as infill panels in this frame.

Panelized curtain walling comprises of large prefabricated panels normally a story height and a bay wide which connect back to the primary structural columns or the floor slab. EQUITONE panels can be used as infill panels in this type of frame. Consultation with the curtain wall supplier is needed to confirm the details.

The panel is held in position like that of the glass with gaskets and trims. Insulation is normally placed behind the panels. The interior then receives another panel to give the required finish.

The maximum size of the panel will depend on the wind loading, and the question of additional central panel support depends on the panel size.

Weatherboard / Shiplap Pattern

An alternative to the flat façade is the shiplap appearance which emphasizes the horizontal lines. This consists of narrow panels fastened to the façade at an angle not parallel to the wall.

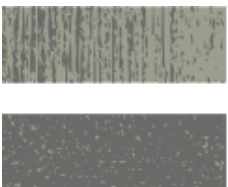
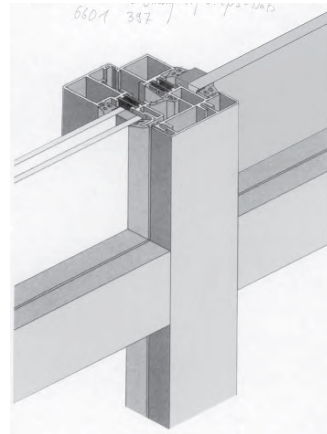

While the vertical joints are spaced at 3/8" (10 mm), the horizontal joints overlap. These can be overlapped close to each other or special spacers are available from support frame suppliers resulting in a stand-off overlap which gives a deeper shadow.

For single, top edge or bottom edge fastening, the panel should be no wider than 12" (305 mm). Any wider than this and the panel should be both top and bottom fastened.

When fastening the shiplap panels to a metal support frame, the same principle of panel fixed and gliding points is necessary. Two fixed points are needed per shiplap plank.

In areas of high wind loading, two rows of fasteners are needed, even with 12" (305 mm) wide panels.

For weatherboarding or shiplap, plank strips are cut from large-size panels which are cut according to individual requirements. Remember the waste factor, especially if the desired plank width is not a multiple of the large panel.

Several patterns are common, from the standard stacked pattern, where the joints for each row are in line, to the layout where the joint in each alternate row are in line, to the free pattern where all joints are staggered.

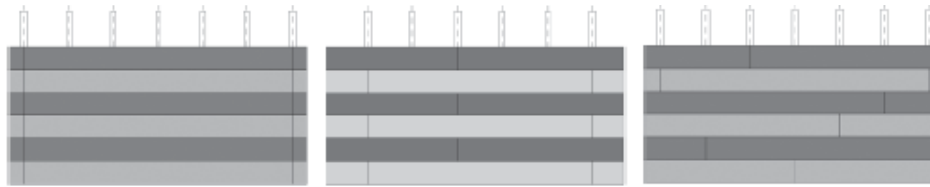

The size of the holes to be drilled in the plank is the same as large panels. Note, all fasteners, whether rivet or screw, must be at 90° to the plank. Adhesive and Tergo+ mechanical fasteners are not possible with this arrangement.

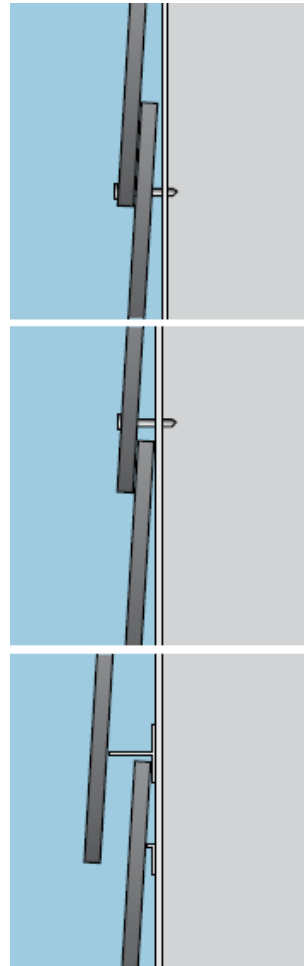

Draft Specification

Ventilated Façade Cladding

Drawing reference(s):	To be inserted by Architect
Primary support structure:	Masonry wall or light-weight metal
Ventilated cladding system:	Drained and back-ventilated system
Rainscreen panel manufacturer and reference:	EQUITONE fiber cement façade panels
Material:	Fiber cement
Thickness:	5/16" (8mm) or 1/2" (12mm)
Finish/color:	From the EQUITONE range
Fastening systems:	Visible or concealed



Visible fasteners:	EQUITONE Uni-Rivets color-matched to panel
Concealed fasteners:	Tergo+ mechanical system
No. & location of fasteners:	See Architect's detail drawings

Joint type:	Open or baffled
Joint width:	3/8" (10 mm)
Cavity depth:	3/4" (20mm)
Support framing system:	Vertical metal profiles
Manufacturer and reference:	To be inserted by Architect
Material:	Aluminum, stainless, or galvanized steel
Anchor fasteners:	Suitable anchors to engineer's detail
No. & location of fasteners:	To support frame supplier's details

Backing wall:	Masonry wall or light-weight metal frame
Thermal insulation:	To Architect's detail
Insulation thickness:	To insulation supplier's detail

Accessories:	
Perforated profile	
External corner trim	
Internal corner trim	
Horizontal joint profile	

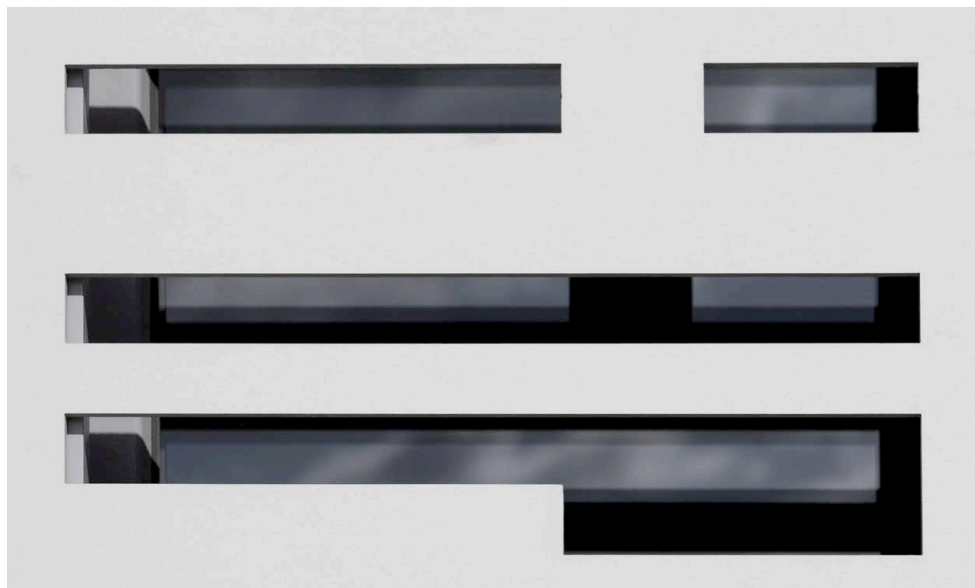

For more information, please contact your designated EQUITONE project manager, or visit our website at:

www.equitone.com

