

Note: The detail numbers above correspond to the following index and pages of this detail book.

DISCLAIMER: These details are provided as a guideline for proper panel and associated component installation, and are based on industry accepted practices. Location of vapor barriers, insulation, and associated flashings and sealants in these details are based on ventilated rainscreen design practices for most U.S climatic Zones. (Primary vapor placed on the “warm” side of the insulation layer. Contact EQUITONE technical services for specific projects located in areas in extreme climate zones that may require modifications to these details. All structural and subframe supports are not by EQUITONE are shown to ensure TZ the contents of this publication are accurate, ETEX, SA/NV Group, and subsidiary companies do not accept responsibility for errors or for information, TZ is Found to be misleading. Suggestions for, or description of, the end use of application of products or methods of working are for information only and ETEX, SA/NV limited and its subsidiaries accept no liability in respect thereof.

EQUITONE EXPOSED FASTENER USING ALUMINUM CLIP AND RAIL SYSTEMS ON STEEL STUD CONSTRUCTION

DETAIL	CONTENT	PAGE
EQ-EF-ALCR-SS-FS	Relation Between Fixed and Sliding Points	4
EQ-EF-ALCR-SS-SUB	Relation Between Sub-Framing and Panel Expansion Points	5
EQ-EF-ALCR-SS-VP	Vertical Profile Details	6
EQ-EF-ALCR-SS-VJ	Vertical Joint Details	7
EQ-EF-ALCR-SS-OHJ	Open Horizontal Joint Details	8
EQ-EF-ALCR-SS-CHJ	Baffled Horizontal Joint Details	9
EQ-EF-ALCR-SS-BGL	Base Detail - Ground Level	10
EQ-EF-ALCR-SS-BOM	Base Detail - Junction with Other Facade Materials Details	11
EQ-EF-ALCR-SS-BCA	Base Detail - Covered Area	12
EQ-EF-ALCR-SS-BFR	Base Detail - Flat Roof	13
EQ-EF-ALCR-SS-BB	Base Detail - Balcony	14
EQ-EF-ALCR-SS-WHS1	Window Head and Sill Details - Option 1	15
EQ-EF-ALCR-SS-WHS2	Window Head and Sill Details - Option 2	16
EQ-EF-ALCR-SS-WJ	Jamb Detail Options	17
EQ-EF-ALCR-SS-C1	Coping Detail - Option 1	18
EQ-EF-ALCR-SS-C2	Coping Detail - Option 2	19
EQ-EF-ALCR-SS-OC	Outside Corner Detail	20
EQ-EF-ALCR-SS-IC	Inside Corner Detail	21
EQ-EF-ALCR-SS-SCO	Soffit / Ceiling Wall Junction - Outside Edge	22
EQ-EF-ALCR-SS-SCI	Soffit / Ceiling Wall Junction - Inside Edge	23
EQ-EF-ALCR-SS-CURVE	Curved Facade Details	24
EQ-EF-ALCR-SS-OM	Junction with Other Facade Materials Details	25
EQ-EF-ALCR-SS-FJ	Exposed Fastener - Concealed Fastener Junction	26

EQUITONE EXPOSED FASTENER USING ALUMINUM CLIP AND RAIL SYSTEMS ON STEEL STUD CONSTRUCTION

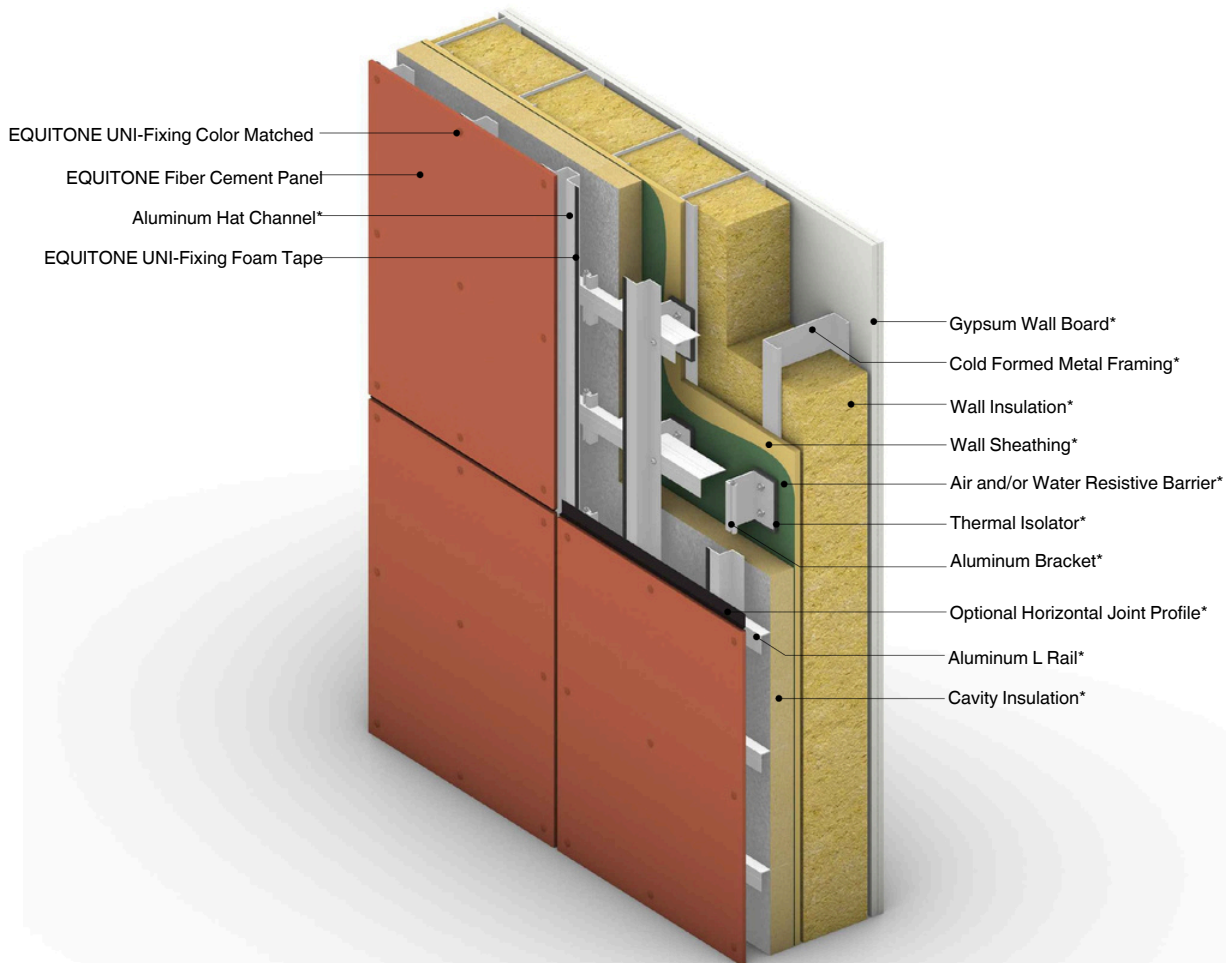

NOTE: THE DETAIL NUMBER ON EACH SHEET CORRESPONDS TO THE INDEX AND PAGE OF THE DETAIL BOOK

DISCLAIMERS:

THESE DETAILS ARE PROVIDED AS A GUIDELINE FOR PROPER PANEL AND ASSOCIATED COMPONENT INSTALLATION, AND ARE BASED ON INDUSTRY ACCEPTED PRACTICES. LOCATION OF VAPOR BARRIERS, INSULATION AND ASSOCIATED FLASHINGS AND SEALANTS IN THESE DETAILS ARE BASED ON VENTILATED RAINSCREEN DESIGN PRACTICES FOR MOST U.S. CLIMATIC ZONES. (THE PRIMARY VAPOR PLACED ON THE "WARM" SIDE OF THE INSULATION LAYER. CONTACT EQUITONE TECHNICAL SERVICES FOR SPECIFIC PROJECTS LOCATED IN AREAS IN EXTREME CLIMATE ZONES WHICH MAY REQUIRE MODIFICATIONS TO THESE DETAILS. ALL STRUCTURAL AND SUBFRAME SUPPORTS ARE NOT BY EQUITONE AND ARE SHOWN FOR CLARIFICATION PURPOSES ONLY. TO ENSURE YOU ARE VIEWING THE MOST RECENT AND ACCURATE PRODUCT APPLICATION GUIDE WWW.EQUITONE.COM. CARE HAS BEEN TAKEN TO ENSURE THAT THE CONTENTS OF THIS PUBLICATION ARE ACCURATE. ETEX, SA/NV GROUP AND SUBSIDIARY COMPANIES DO NOT ACCEPT RESPONSIBILITY FOR ERRORS OR FOR INFORMATION THAT IS FOUND TO BE MISLEADING. SUGGESTIONS FOR, OR DESCRIPTION OF, THE END USE OR APPLICATION OF PRODUCTS OR METHODS OF WORKING ARE FOR INFORMATION ONLY AND ETEX, SA/NV LIMITED AND ITS SUBSIDIARIES ACCEPT NO LIABILITY IN RESPECT THEREOF.



RELEASE:202412
REGION:NORTH AMERICA
WWW.EQUITONE.COM

3D ASSEMBLY
DETAIL

EQUITONE EXPOSED FASTENER USING ALUMINUM CLIP AND RAIL SYSTEMS ON STEEL STUD CONSTRUCTION

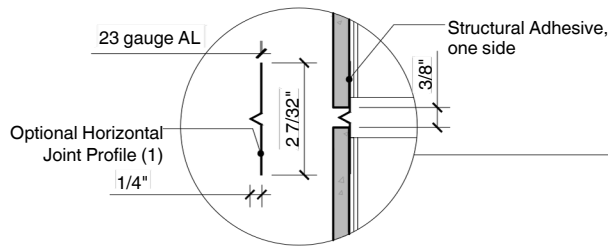

UNI-Rivet Gliding Point
(green/GO spacer only)

UNI-Metal Screw
Gliding Point



UNI-Rivet Fixed Point
(green/GO spacer +
red/STOP spacer)

UNI-Metal Screw
Fixed Point
(red/STOP spacer)

NOTE: All details shown in this set can utilize either the UNI-Rivet or UNI-Metal Screw type fixings shown above.

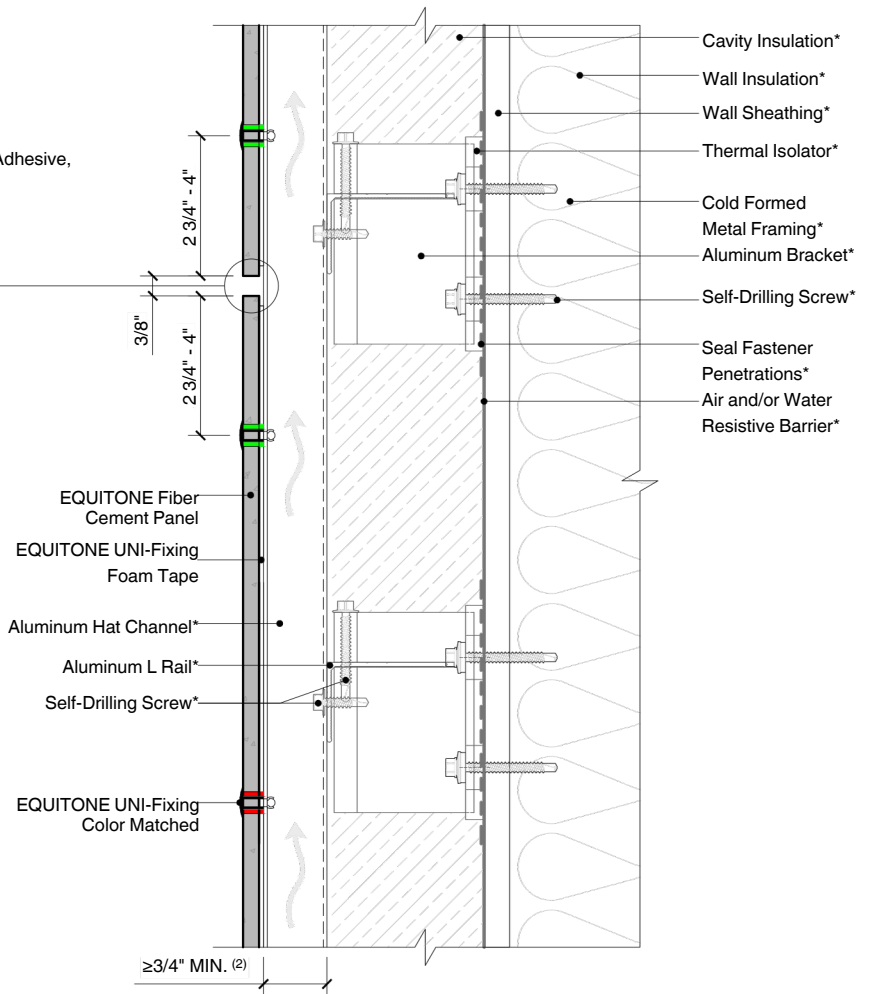

NOTES:

1. Flashing used to close the joints may not be thicker as 1/32 in (23 gauge), including the thickness of any fastener heads.
2. Inlet/Outlet, air cavity, and closure perforation sizing should be modified, from those expressed herein, depending upon building height and/or local legislation. Visit the Planning and Application Guide - Face Fixing to Metal for additional information.
3. (*) symbol represents materials not supplied by EQUITONE.



DETAIL #:EQ-EF-ALCR-SS-FS
RELEASE:202412
REGION: NORTH AMERICA
WWW.EQUITONE.COM

RELATION BETWEEN
FIXED AND
SLIDING POINTS

EQUITONE EXPOSED FASTENER USING ALUMINUM CLIP AND RAIL SYSTEMS ON STEEL STUD CONSTRUCTION

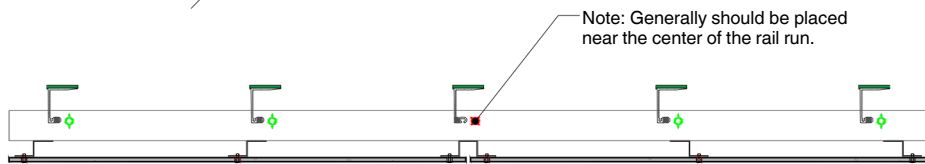
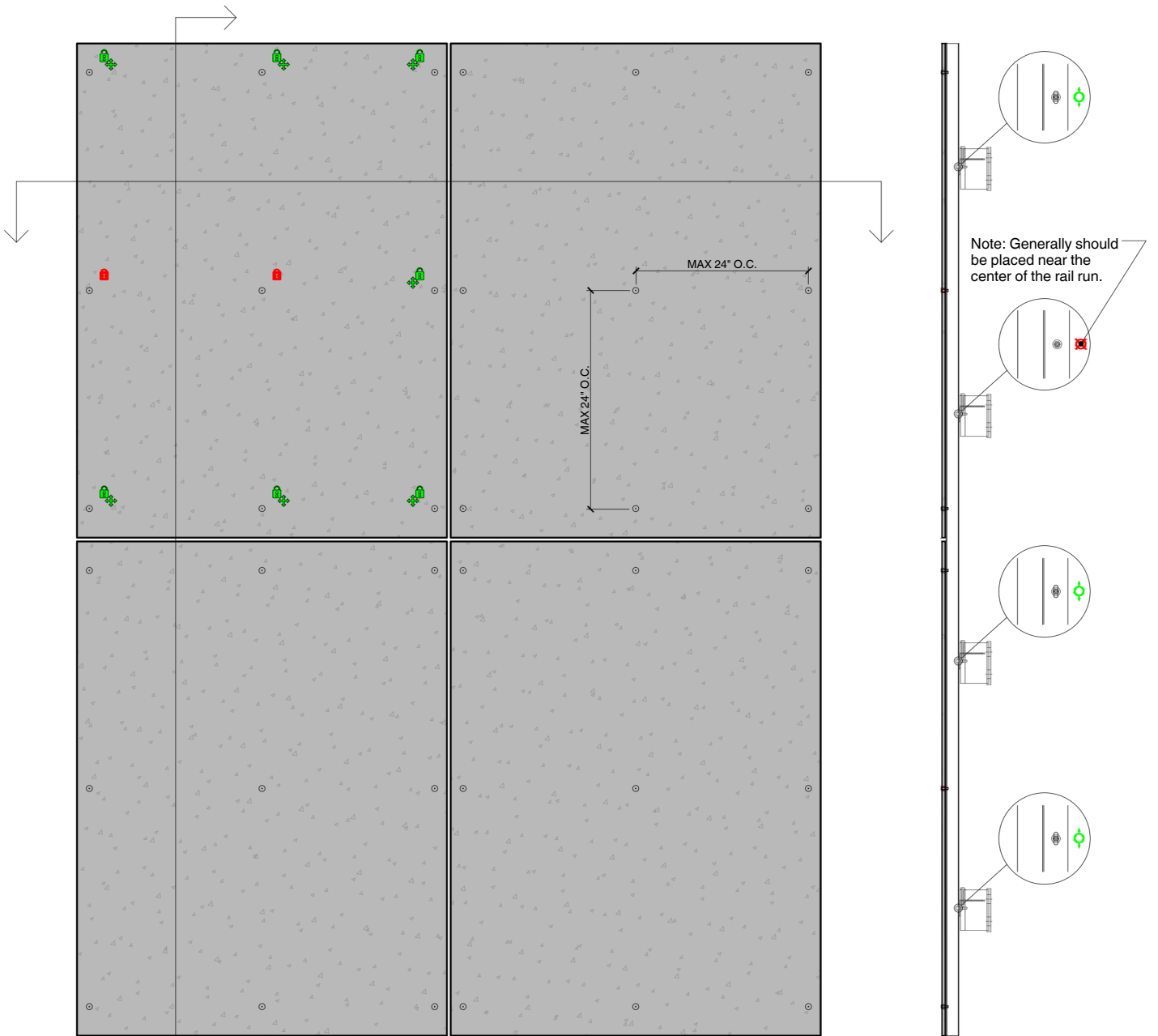

NOTES:

1. The following is a representation of the importance of allowing the sub-framing system to expand and contract in addition to the movement within the UNI-fixing systems. These are general guidelines and do not encompass all situations.
2. Recommend maximum rail lengths to be 10'-0".



DETAIL #:EQ-EF-ALCR-SS-SUB
RELEASE:202412
REGION: NORTH AMERICA
WWW.EQUITONE.COM

RELATION BETWEEN SUB-FRAMING AND PANEL EXPANSION POINTS

EQUITONE EXPOSED FASTENER USING ALUMINUM CLIP AND RAIL SYSTEMS ON STEEL STUD CONSTRUCTION

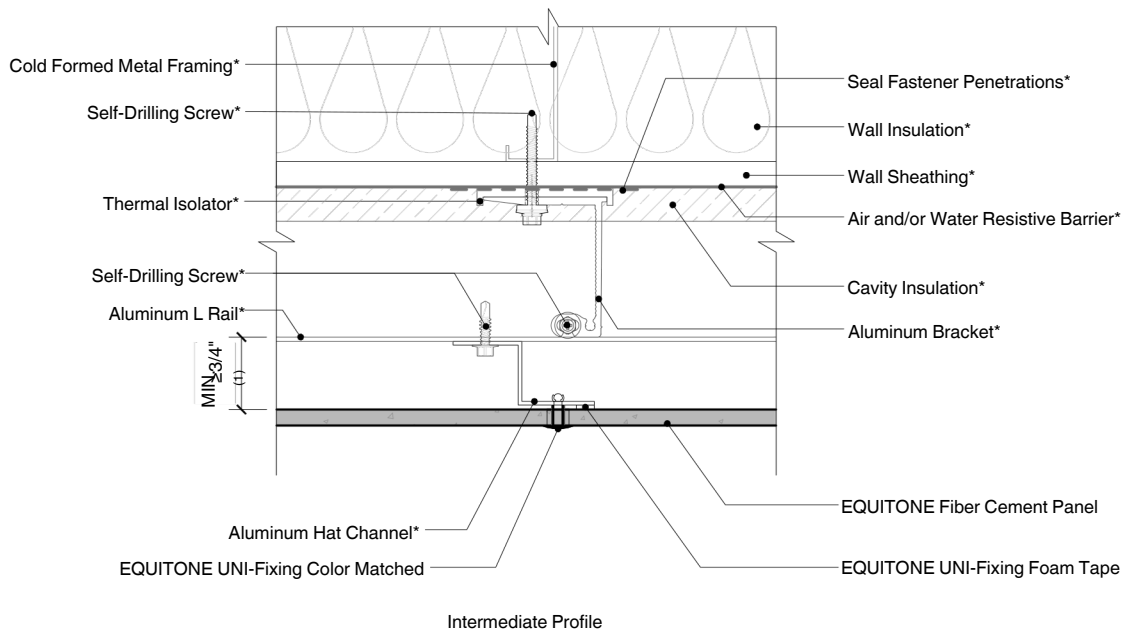
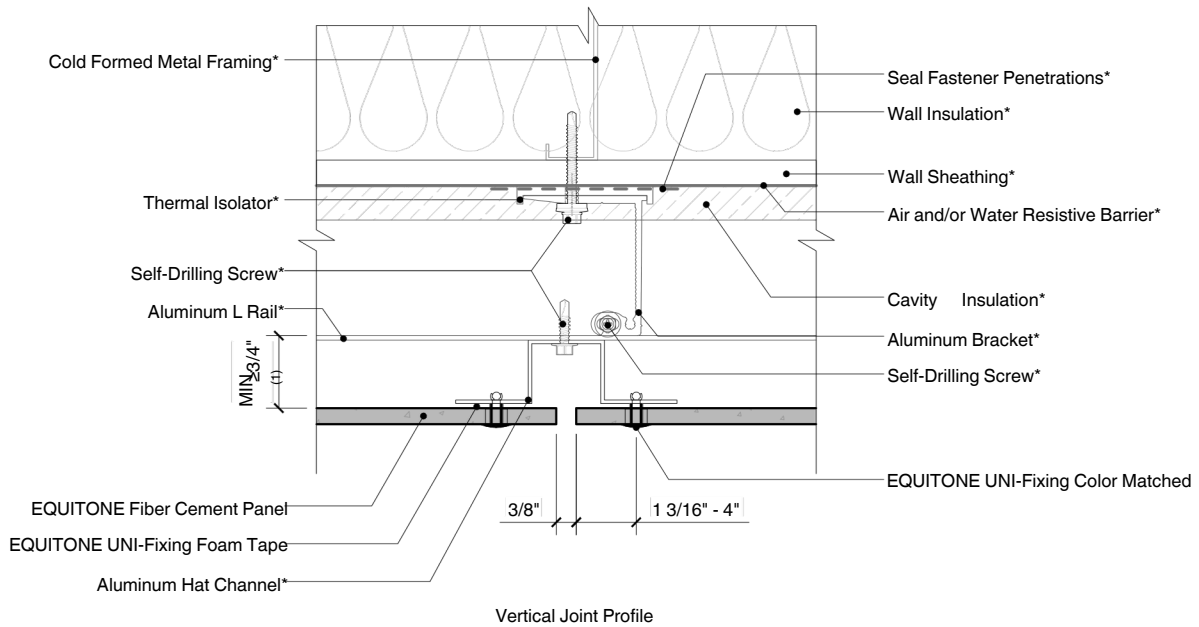

NOTES:

1. Inlet/Outlet, air cavity, and closure perforation sizing should be modified, from those expressed herein, depending upon building height and/or local legislation. Visit the Planning and Application Guide - Face Fixing to Metal for additional information.
2. (*) symbol represents materials not supplied by EQUITONE.



DETAIL #:EQ-EF-ALCR-SS-VP
RELEASE:202412
REGION: NORTH AMERICA
WWW.EQUITONE.COM

VERTICAL
PROFILE DETAILS

EQUITONE EXPOSED FASTENER USING ALUMINUM CLIP AND RAIL SYSTEMS ON STEEL STUD CONSTRUCTION

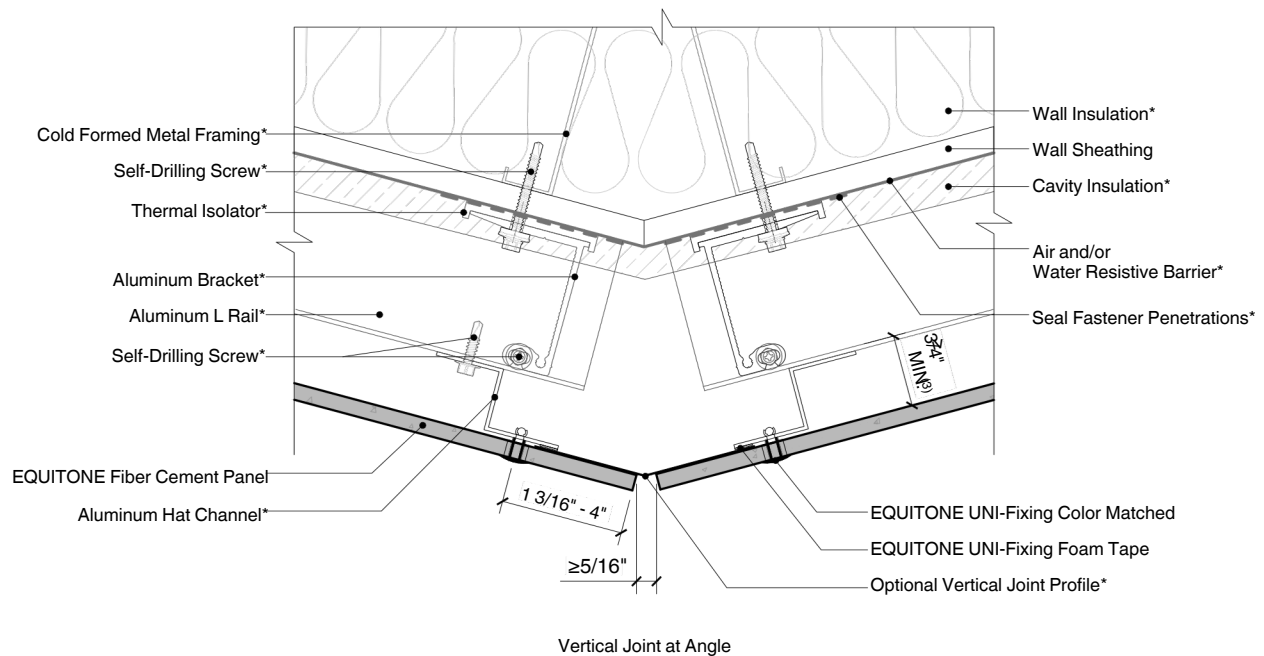
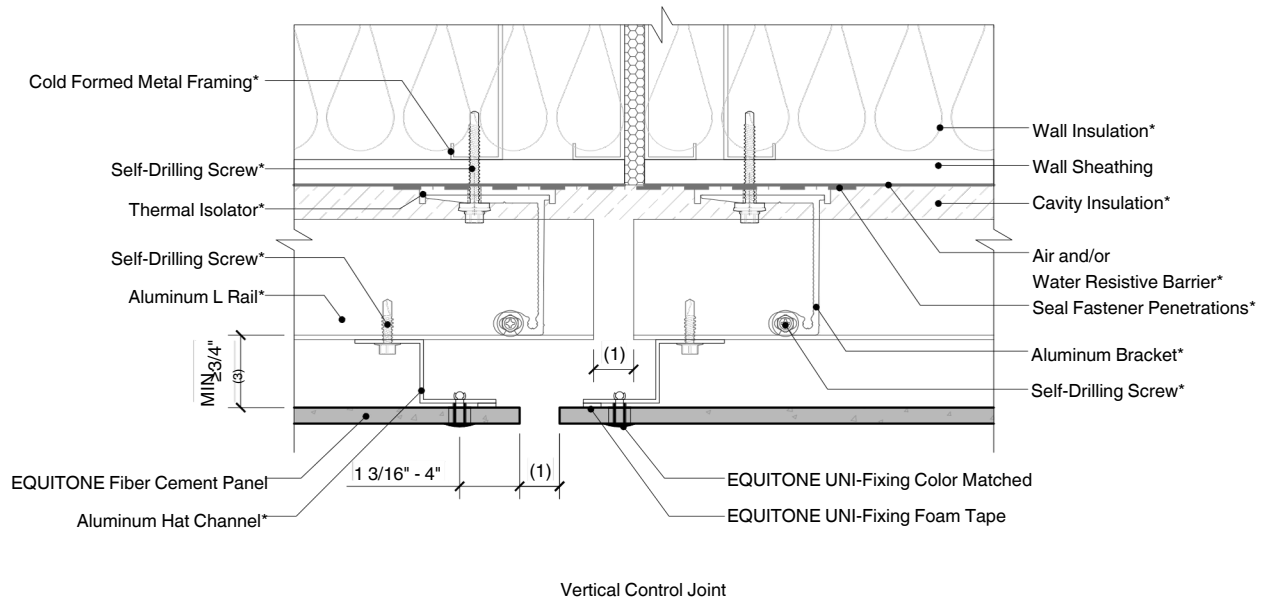

NOTES:

1. The width of the the facade control joint should be equal or greater than the building control joint.
2. Flashing used to close the joints may not be thicker as 1/32 in (23 gauge), including the thickness of any fastener heads.
3. Inlet/Outlet, air cavity, and closure perforation sizing should be modified, from those expressed herein, depending upon building height and/or local legislation. Visit the Planning and Application Guide - Face Fixing to Metal for additional information.
4. (*) symbol represents materials not supplied by EQUITONE.



DETAIL #:EQ-EF-ALCR-SS-VJ
RELEASE:202412
REGION: NORTH AMERICA
WWW.EQUITONE.COM

VERTICAL JOINT DETAILS

EQUITONE EXPOSED FASTENER USING ALUMINUM CLIP AND RAIL SYSTEMS ON STEEL STUD CONSTRUCTION

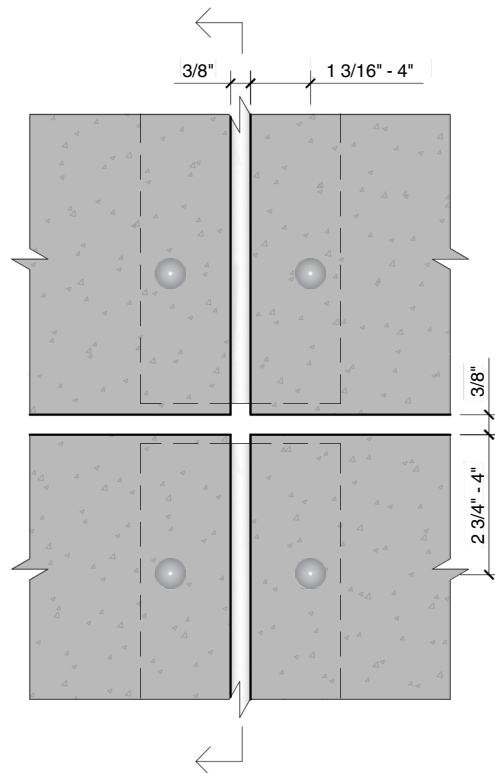
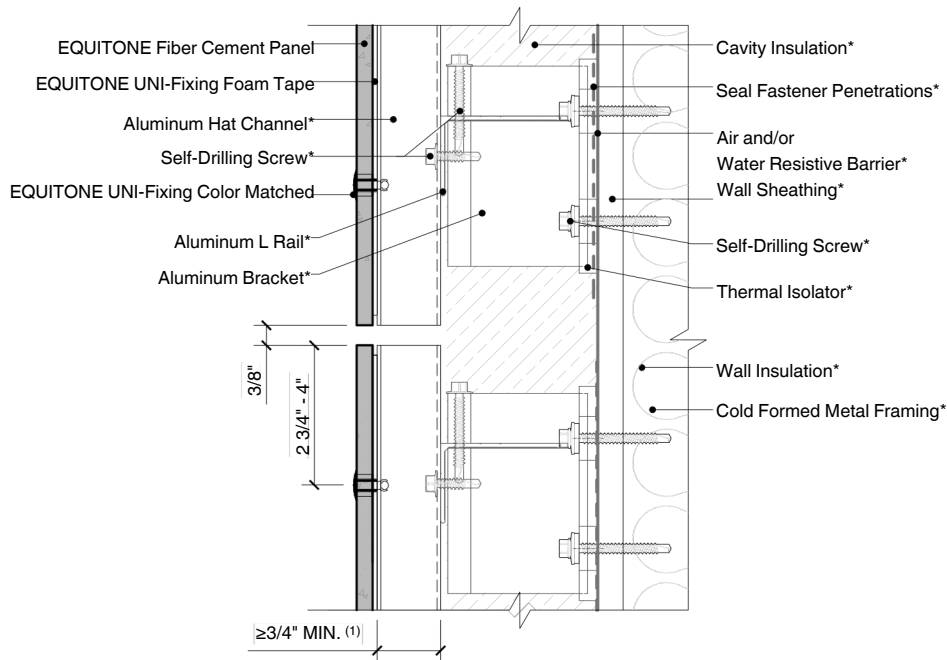

NOTES:

1. Inlet/Outlet, air cavity, and closure perforation sizing should be modified, from those expressed herein, depending upon building height and/or local legislation. Visit the Planning and Application Guide - Face Fixing to Metal for additional information.
2. (*) symbol represents materials not supplied by EQUITONE.



DETAIL #:EQ-EF-ALCR-SS-OHJ

RELEASE:202412

REGION: NORTH AMERICA

WWW.EQUITONE.COM

OPEN HORIZONTAL
JOINT DETAILS

EQUITONE EXPOSED FASTENER USING ALUMINUM CLIP AND RAIL SYSTEMS ON STEEL STUD CONSTRUCTION

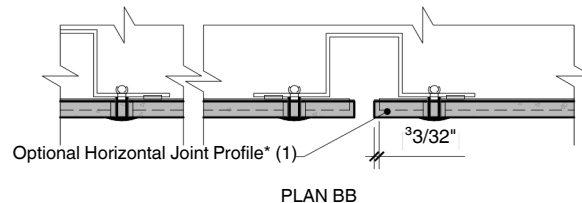
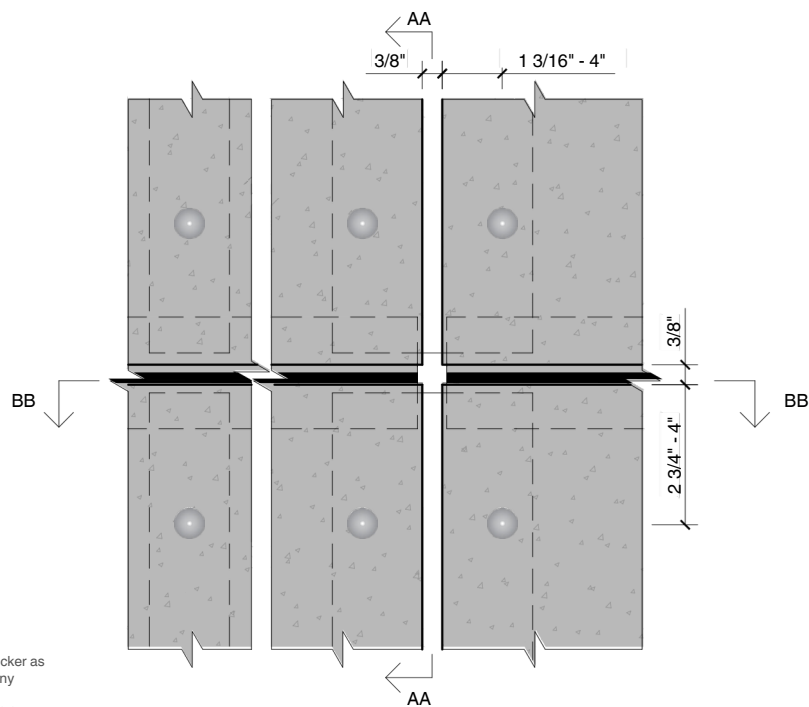
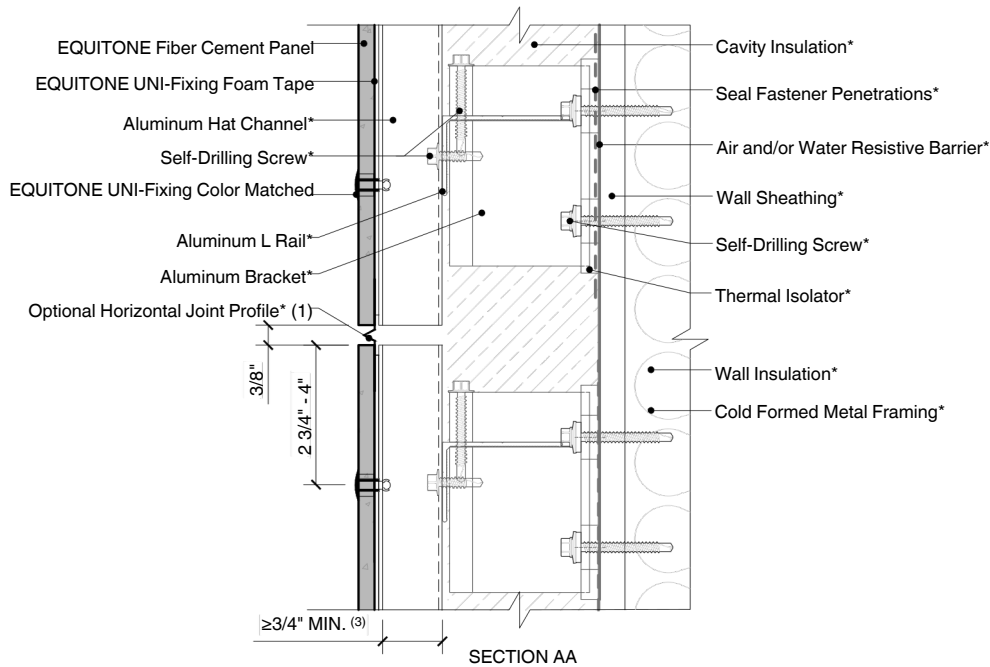

NOTES:

1. Flashing used to close the joints may not be thicker as 1/32 in (23 gauge), including the thickness of any fastener heads.
2. Closing the horizontal joint may increase the minimum ventilation requirements. See EQUITONE Planning and Application Guide for more information.
3. Inlet/Outlet, air cavity, and closure perforation sizing should be modified, from those expressed herein, depending upon building height and/or local legislation. Visit the Planning and Application Guide - Face Fixing to Metal for additional information.
4. (*) symbol represents materials not supplied by EQUITONE.



DETAIL #:EQ-EF-ALCR-SS-CHJ

RELEASE:202412

REGION: NORTH AMERICA

WWW.EQUITONE.COM

**BAFFLED HORIZONTAL
JOINT DETAILS**

EQUITONE EXPOSED FASTENER USING ALUMINUM CLIP AND RAIL SYSTEMS ON STEEL STUD CONSTRUCTION

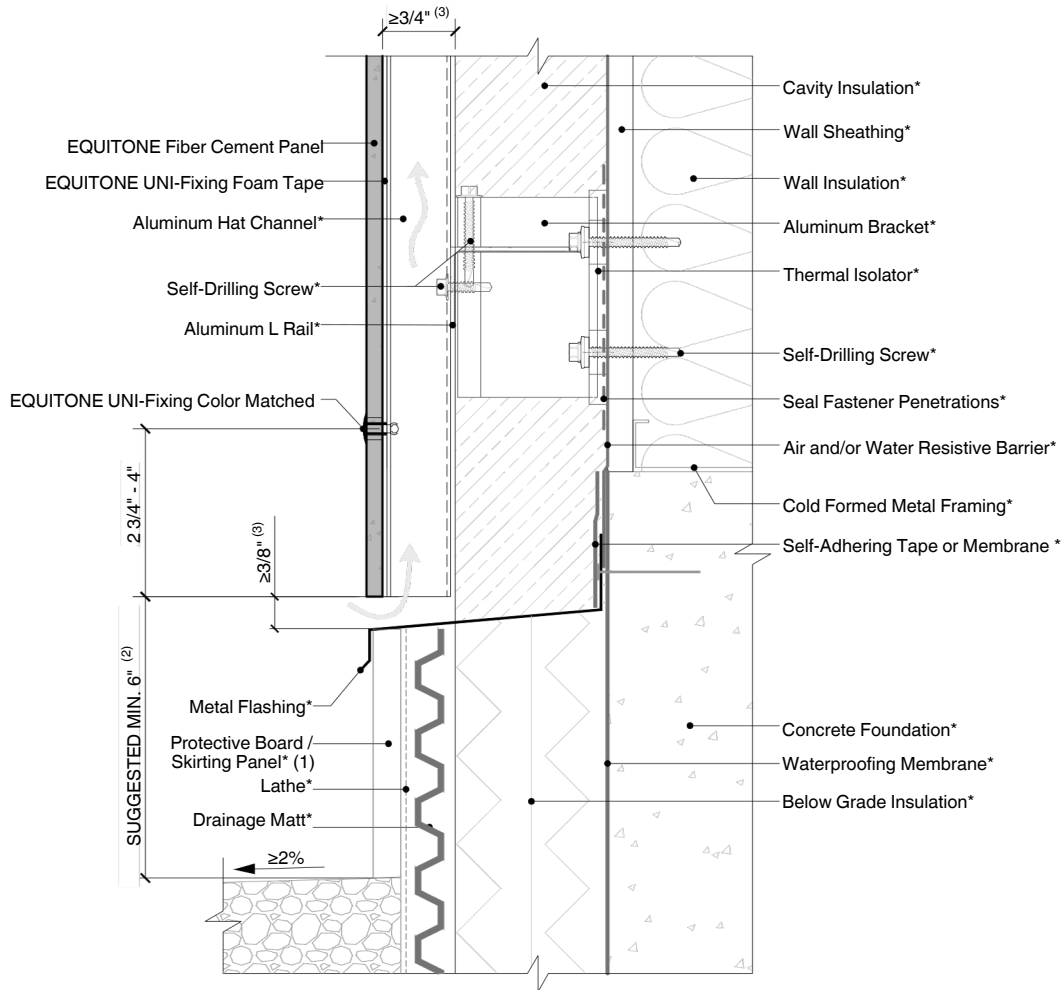

NOTES:

1. The skirting board could be concrete, natural stone, render, metal flashing, etc.
2. A smaller ground clearance is possible, but it may increase the risk of water marks and panel staining caused by splash back.
3. Inlet/Outlet, air cavity, and closure perforation sizing should be modified, from those expressed herein, depending upon building height and/or local legislation. Visit the Planning and Application Guide - Face Fixing to Metal for additional information.
4. (*) symbol represents materials not supplied by EQUITONE.



DETAIL #: EQ-EF-ALCR-SS-BGL

RELEASE: 202412

REGION: NORTH AMERICA

WWW.EQUITONE.COM

**BASE DETAIL -
GROUND LEVEL**

EQUITONE EXPOSED FASTENER USING ALUMINUM CLIP AND RAIL SYSTEMS ON STEEL STUD CONSTRUCTION

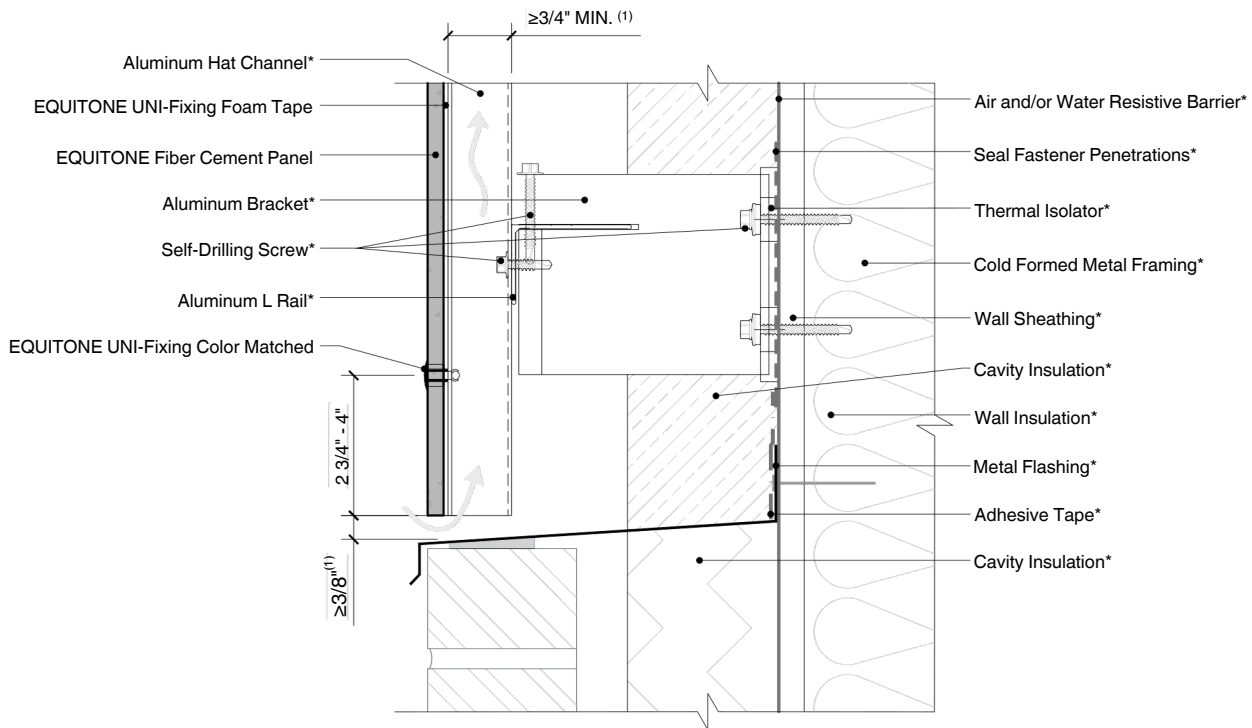

NOTES:

- 1. Inlet/Outlet, air cavity, and closure perforation sizing should be modified, from those expressed herein, depending upon building height and/or local legislation. Visit the Planning and Application Guide - Face Fixing to Metal for additional information.
- 2. (*) symbol represents materials not supplied by EQUITONE.



DETAIL #:EQ-EF-ALCR-SS-BOM
RELEASE:202412
REGION: NORTH AMERICA
WWW.EQUITONE.COM

BASE DETAIL - JUNCTION WITH OTHER FACADE MATERIAL DETAIL

EQUITONE EXPOSED FASTENER USING ALUMINUM CLIP AND RAIL SYSTEMS ON STEEL STUD CONSTRUCTION

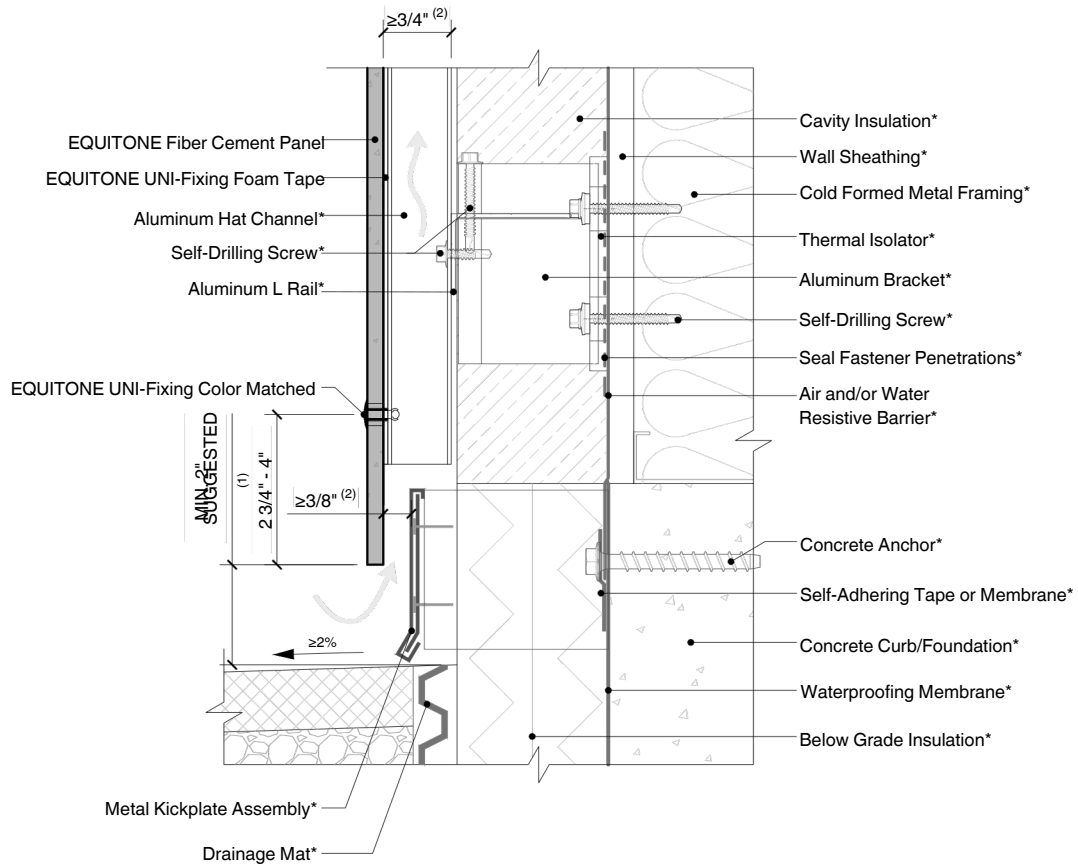

NOTES:

1. A smaller ground clearance is possible, but it may increase the risk of water marks and panel staining caused by splash back.
2. Inlet/Outlet, air cavity, and closure perforation sizing should be modified, from those expressed herein, depending upon building height and/or local legislation. Visit the Planning and Application Guide - Face Fixing to Metal for additional information.
3. (*) symbol represents materials not supplied by EQUITONE.



DETAIL #:EQ-EF-ALCR-SS-BCA
RELEASE:202412
REGION: NORTH AMERICA
WWW.EQUITONE.COM

**BASE DETAIL -
COVERED AREA**

EQUITONE EXPOSED FASTENER USING ALUMINUM CLIP AND RAIL SYSTEMS ON STEEL STUD CONSTRUCTION

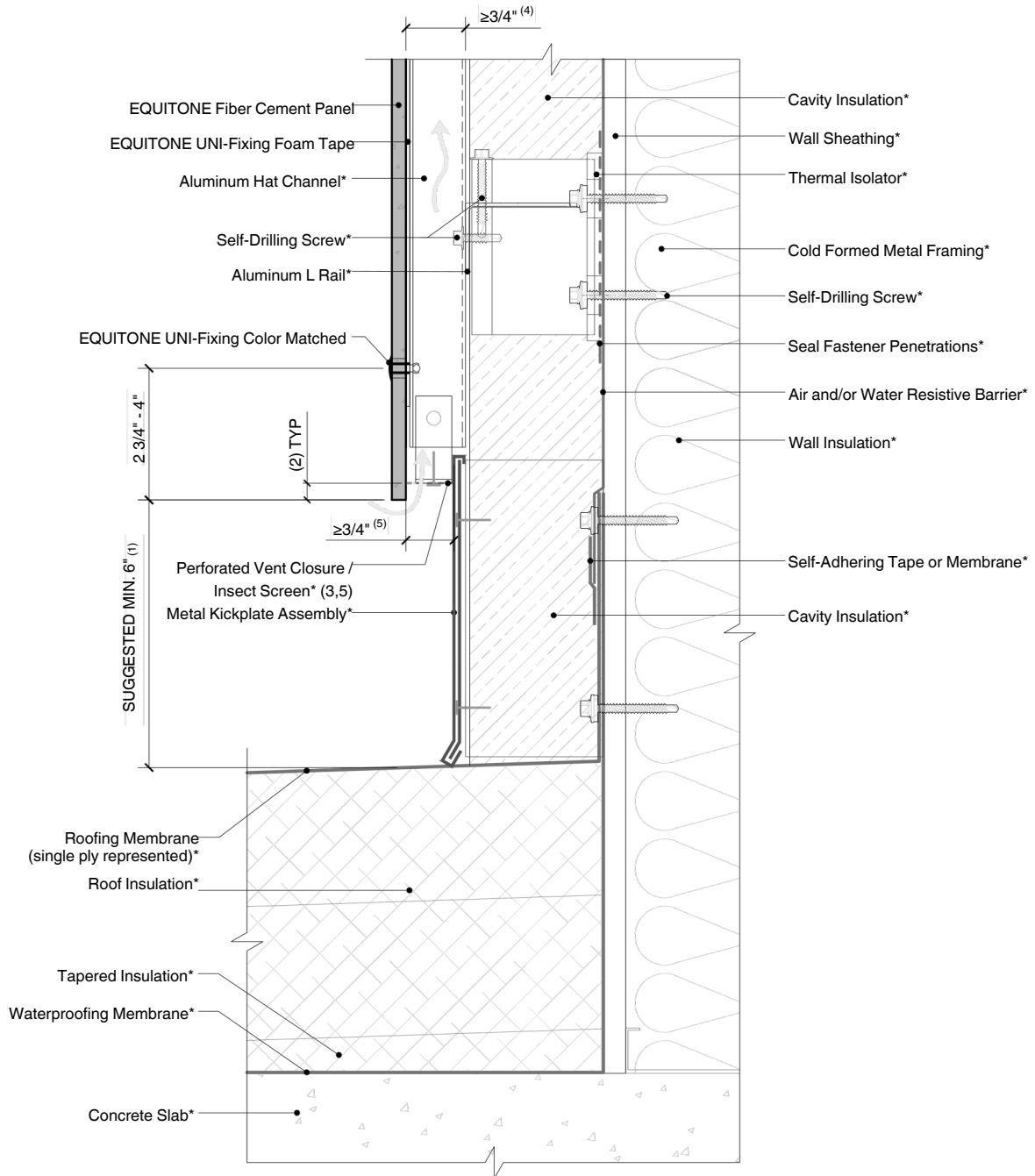

NOTES:

1. A smaller ground clearance is possible, but it may increase the risk of water marks and panel staining caused by splash back.
2. The facade panel should preferably overhang more than 3/8 in below the ventilation profile to create a drip edge.
3. All closures, trims, screens, etc. should be held off the back of the panel by at least 1/16 inch.
4. Inlet/Outlet, air cavity, and closure perforation sizing should be modified, from those expressed herein, depending upon building height and/or local legislation. Visit the Planning and Application Guide - Face Fixing to Metal for additional information.
5. When the inlet/outlet is wider than 3/4 inch continuous, a perforated closure is recommended to prevent debris build up. The perforation pattern should allow the same volume of air to pass through as the specified continuous open joint size specified in EQUITONE guidelines.
6. Where a perforated closure is not obstructing the inlet/outlet, the opening should be a minimum of 3/8 inch continuous.
7. (*) symbol represents materials not supplied by EQUITONE.



DETAIL #:EQ-EF-ALCR-SS-BFR
RELEASE:202412
REGION: NORTH AMERICA
WWW.EQUITONE.COM

**BASE DETAIL -
FLAT ROOF**

EQUITONE EXPOSED FASTENER USING ALUMINUM CLIP AND RAIL SYSTEMS ON STEEL STUD CONSTRUCTION

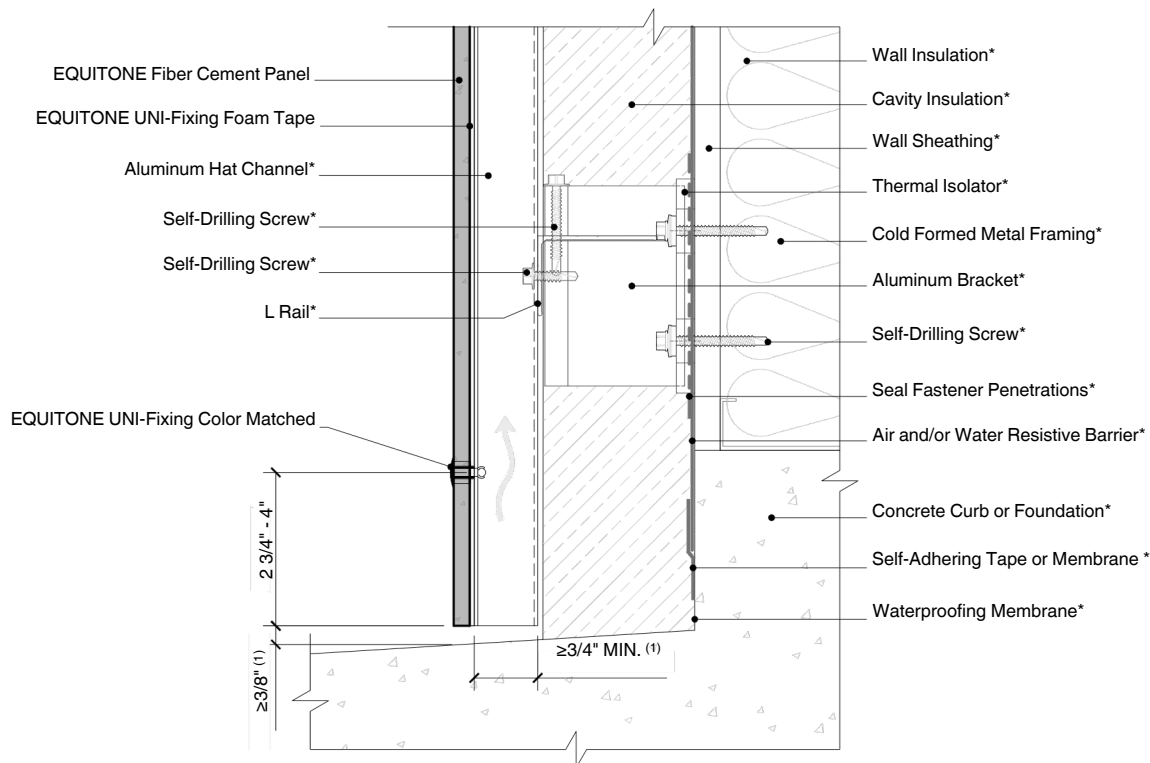

NOTES:

1. Inlet/Outlet, air cavity, and closure perforation sizing should be modified, from those expressed herein, depending upon building height and/or local legislation. Visit the Planning and Application Guide - Face Fixing to Metal for additional information.
2. (*) symbol represents materials not supplied by EQUITONE.



DETAIL #:EQ-EF-ALCR-SS-BB

RELEASE:202412

REGION: NORTH AMERICA

WWW.EQUITONE.COM

**BASE DETAIL -
BALCONY**

EQUITONE EXPOSED FASTENER USING ALUMINUM CLIP AND RAIL SYSTEMS ON STEEL STUD CONSTRUCTION

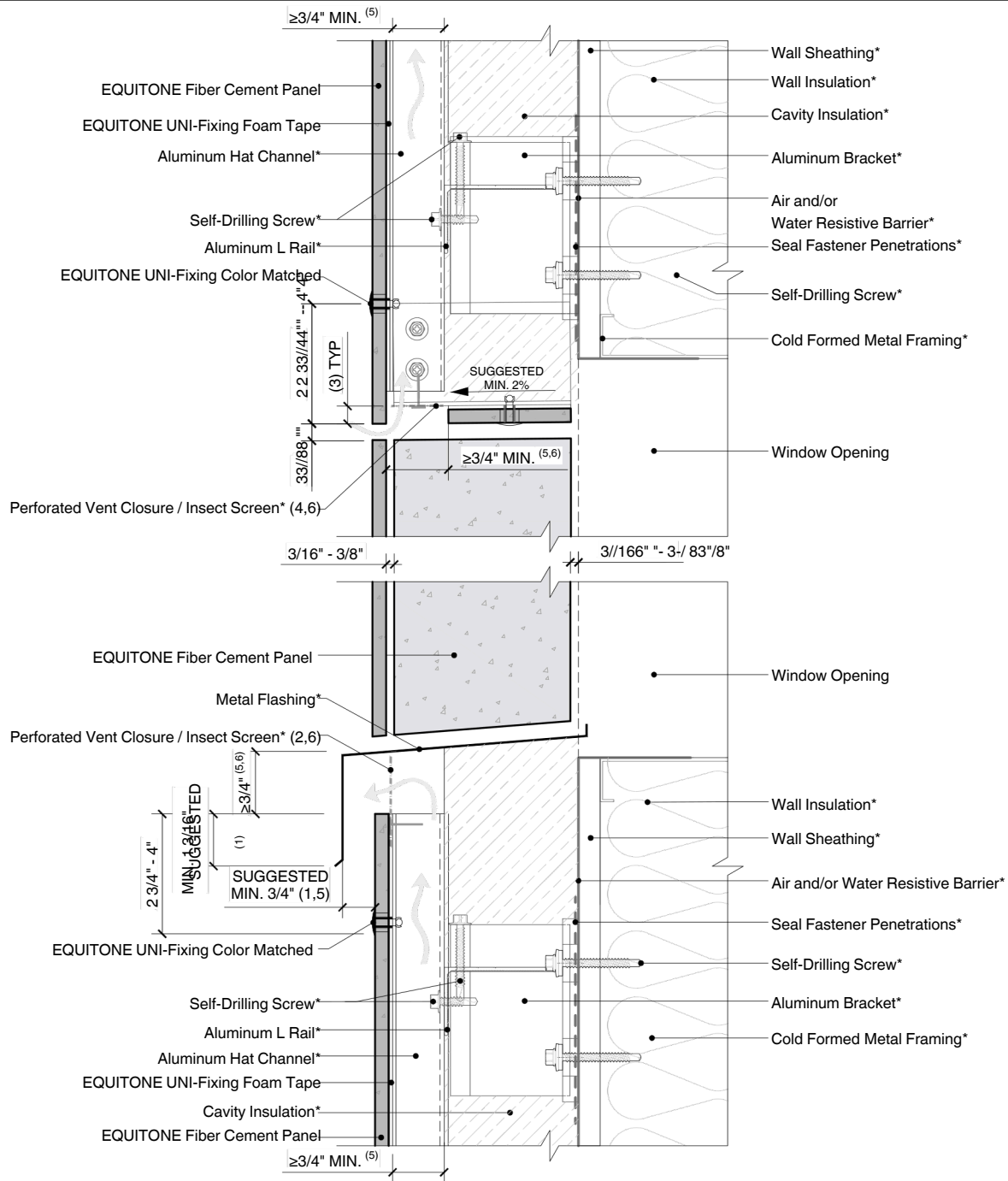

NOTES:

1. A smaller overlap or offset is possible, but it may increase the risk of water marks and panel staining caused by runoff. Smaller capping is also more prone to wind driven rain entering the cavity. At minimum, EQUITONE's ventilation guidelines must be followed.
2. Flashing used to close the joints may not be thicker than 1/32 inch (23 gauge), including the thickness of any fastener heads.
3. The facade panel should preferably overhang more than 3/8 inch below the ventilation profile to create a drip edge.
4. All closures, trims, screens, etc. should be held off the back of the panel by at least 1/16 inch.
5. Inlet/Outlet, air cavity, and closure perforation sizing should be modified, from those expressed herein, depending upon building height and/or local legislation. Visit the Planning and Application Guide - Face Fixing to Metal for additional information.
6. When the inlet/outlet is wider than 3/4 inch continuous, a perforated closure is recommended to prevent debris build up. The perforation pattern should allow the same volume of air to pass through as the specified continuous open joint size specified in EQUITONE guidelines.
7. Where a perforated closure is not obstructing the inlet/outlet, the opening should be a minimum of 3/8 inch continuous.
8. (*) symbol represents materials not supplied by EQUITONE.



DETAIL #:EQ-EF-ALCR-SS-WHS1
RELEASE:202412
REGION: NORTH AMERICA
WWW.EQUITONE.COM

WINDOW HEAD AND
SILL DETAILS -
OPTION 1

EQUITONE EXPOSED FASTENER USING ALUMINUM CLIP AND RAIL SYSTEMS ON STEEL STUD CONSTRUCTION

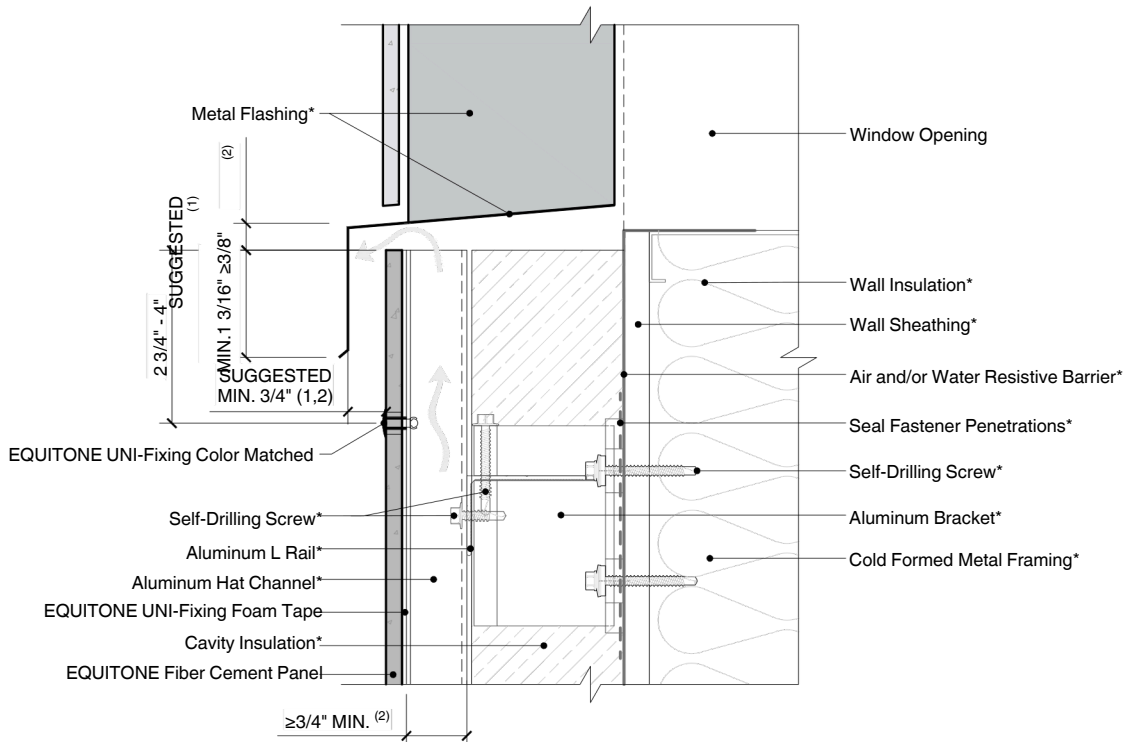
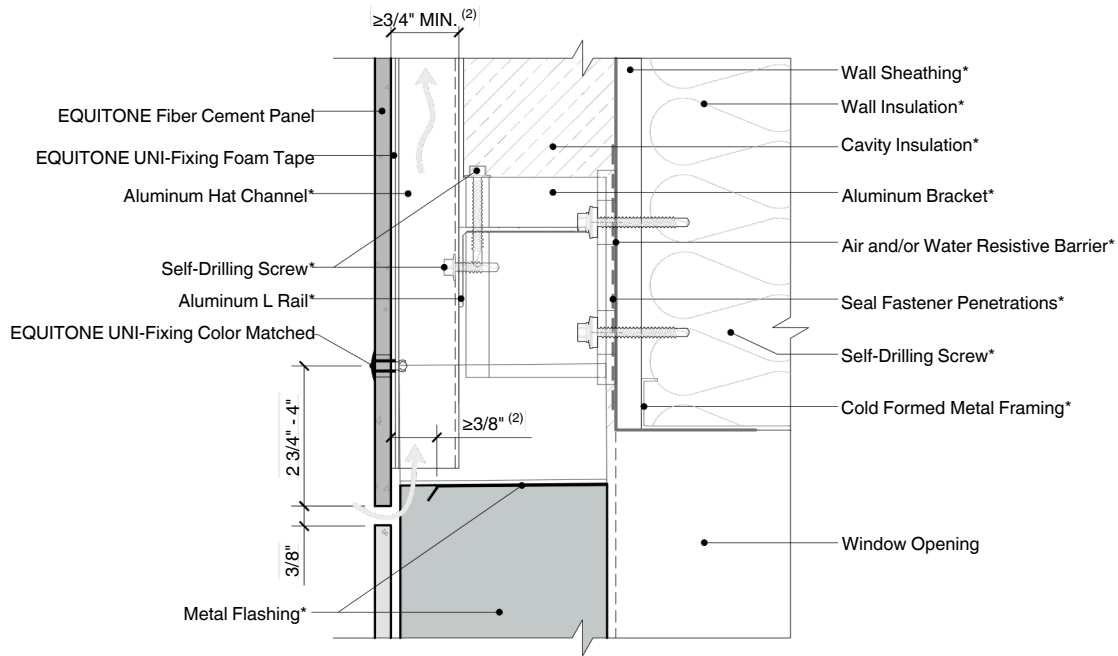

NOTES:

1. A smaller overlap or offset is possible, but it may increase the risk of water marks and panel staining caused by runoff. Smaller capping is also more prone to wind driven rain entering the cavity. At minimum, EQUITONE's ventilation guidelines must be followed.
2. Inlet/Outlet, air cavity, and closure perforation sizing should be modified, from those expressed herein, depending upon building height and/or local legislation. Visit the Planning and Application Guide - Face Fixing to Metal for additional information.
3. (*) symbol represents materials not supplied by EQUITONE.



DETAIL #:EQ-EF-ALCR-SS-WHS2

RELEASE:202412

REGION: NORTH AMERICA

WWW.EQUITONE.COM

WINDOW HEAD AND SILL DETAILS - OPTION 2

EQUITONE EXPOSED FASTENER USING ALUMINUM CLIP AND RAIL SYSTEMS ON STEEL STUD CONSTRUCTION

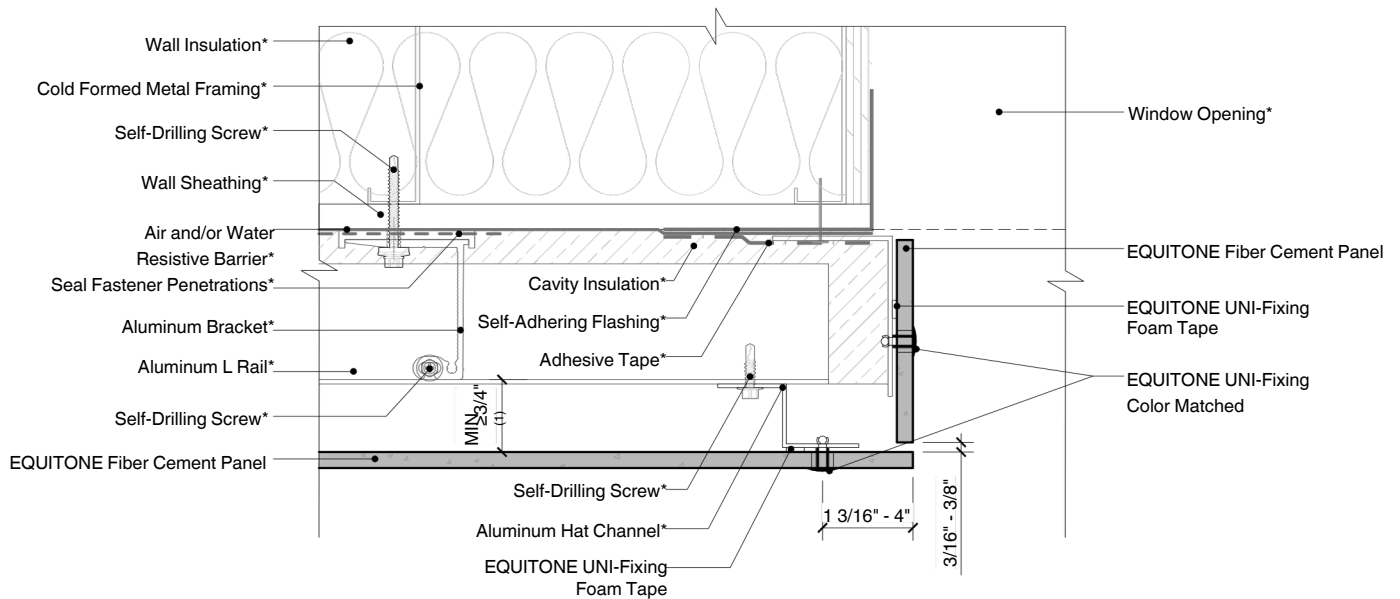

Jamb Detail - Option 1

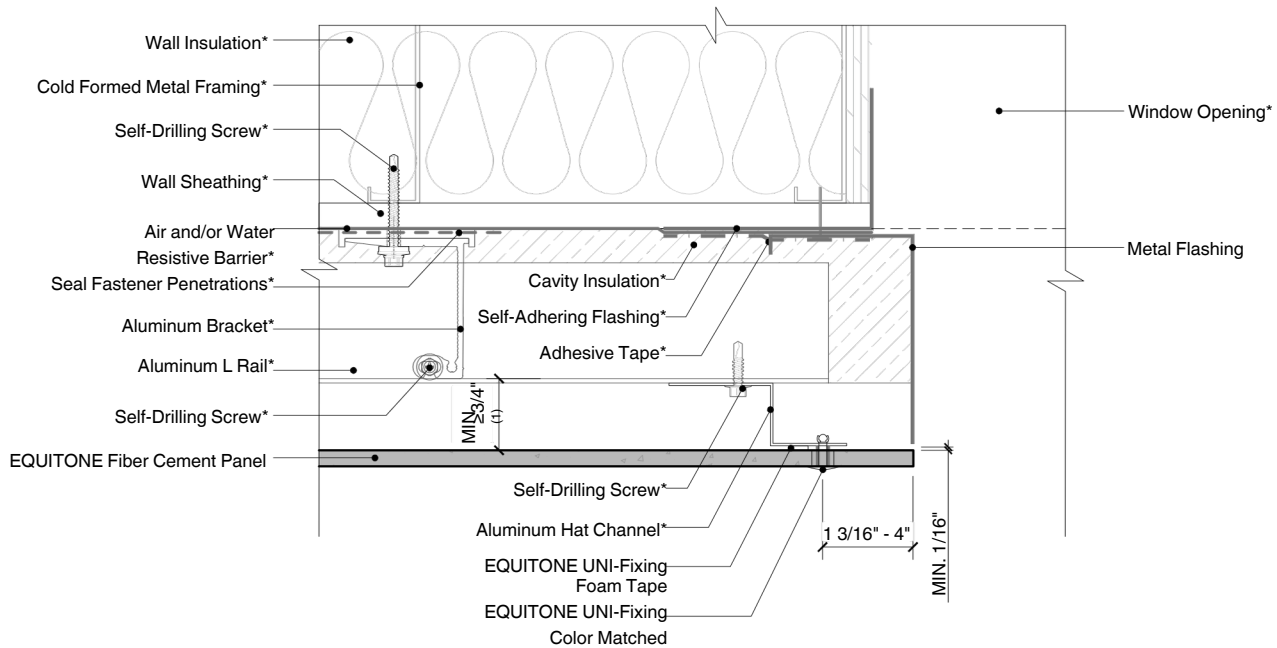

Jamb Detail - Option 2

NOTES:

1. Inlet/Outlet, air cavity, and closure perforation sizing should be modified, from those expressed herein, depending upon building height and/or local legislation. Visit the Planning and Application Guide - Face Fixing to Metal for additional information.
2. (*) symbol represents materials not supplied by EQUITONE.



DETAIL #:EQ-EF-ALCR-SS-WJ

RELEASE:202412

REGION: NORTH AMERICA

WWW.EQUITONE.COM

JAMB DETAIL
OPTIONS

EQUITONE EXPOSED FASTENER USING ALUMINUM CLIP AND RAIL SYSTEMS ON STEEL STUD CONSTRUCTION

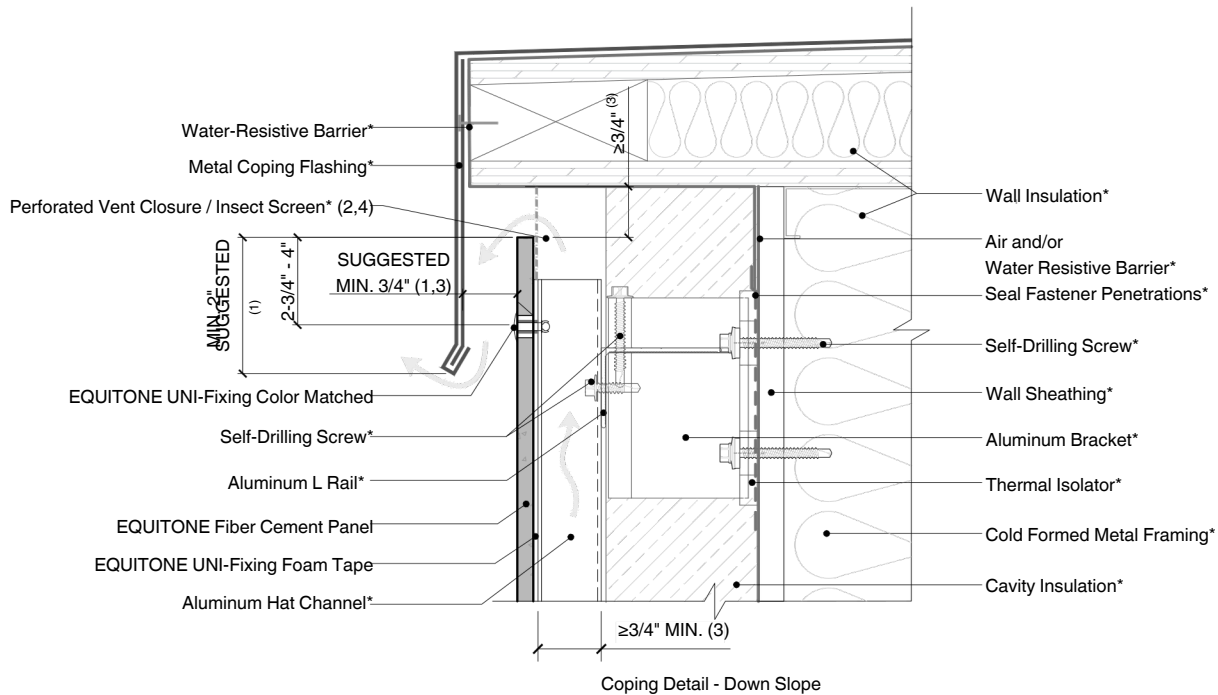
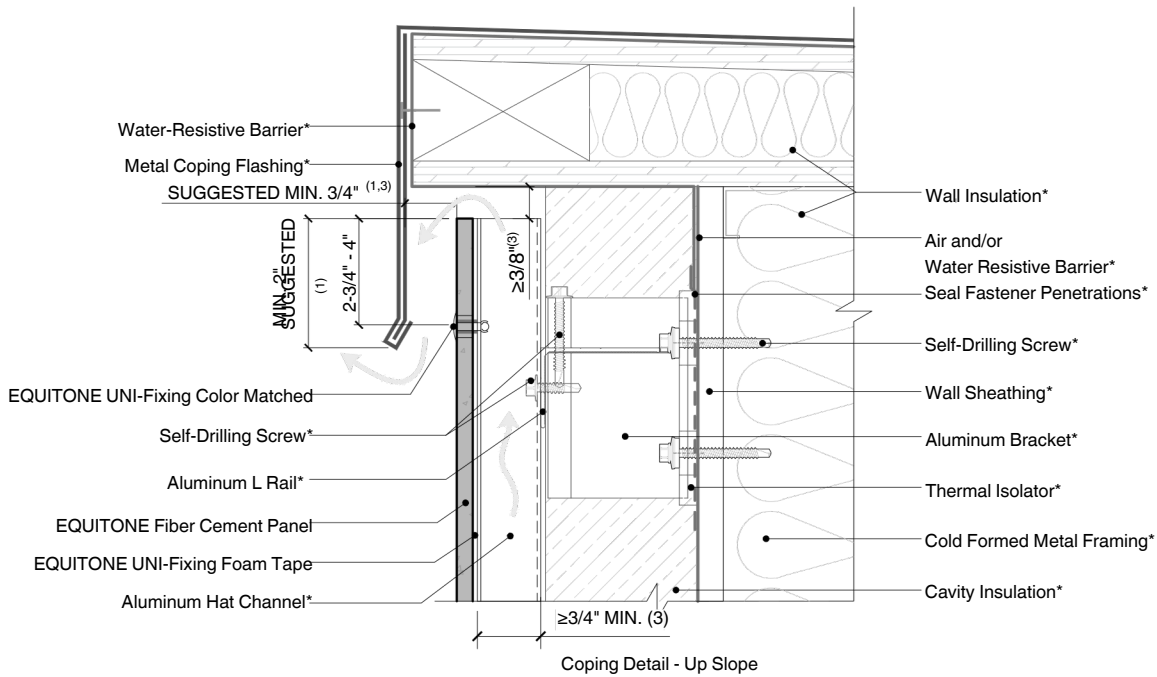

NOTES:

1. A smaller overlap or offset is possible, but it may increase the risk of water marks and panel staining caused by runoff. Smaller capping is also more prone to wind driven rain entering the cavity. At minimum, EQUITONE's ventilation guidelines must be followed.
2. All closures, trims, screens, etc. should be held off the back of the panel by at least 1/16 inch.
3. Inlet/Outlet, air cavity, and closure perforation sizing should be modified, from those expressed herein, depending upon building height and/or local legislation. Visit the Planning and Application Guide - Face Fixing to Metal for additional information.
4. When the inlet/outlet is wider than 3/4 inch continuous, a perforated closure is recommended to prevent debris build up. The perforation pattern should allow the same volume of air to pass through as the specified continuous open joint size specified in EQUITONE guidelines. The depicted screen is 70% perforated with a 1-7/16 inch opening equating to a continuous open joint size of 1 inch.
5. Where a perforated closure is not obstructing the inlet/outlet, the opening should be a minimum of 3/8 inch continuous.
6. (*) symbol represents materials not supplied by EQUITONE.



DETAIL #: EQ-EF-ALCR-SS-C1
RELEASE: 202412
REGION: NORTH AMERICA
WWW.EQUITONE.COM

**COPING DETAIL -
OPTION 1**

EQUITONE EXPOSED FASTENER USING ALUMINUM CLIP AND RAIL SYSTEMS ON STEEL STUD CONSTRUCTION

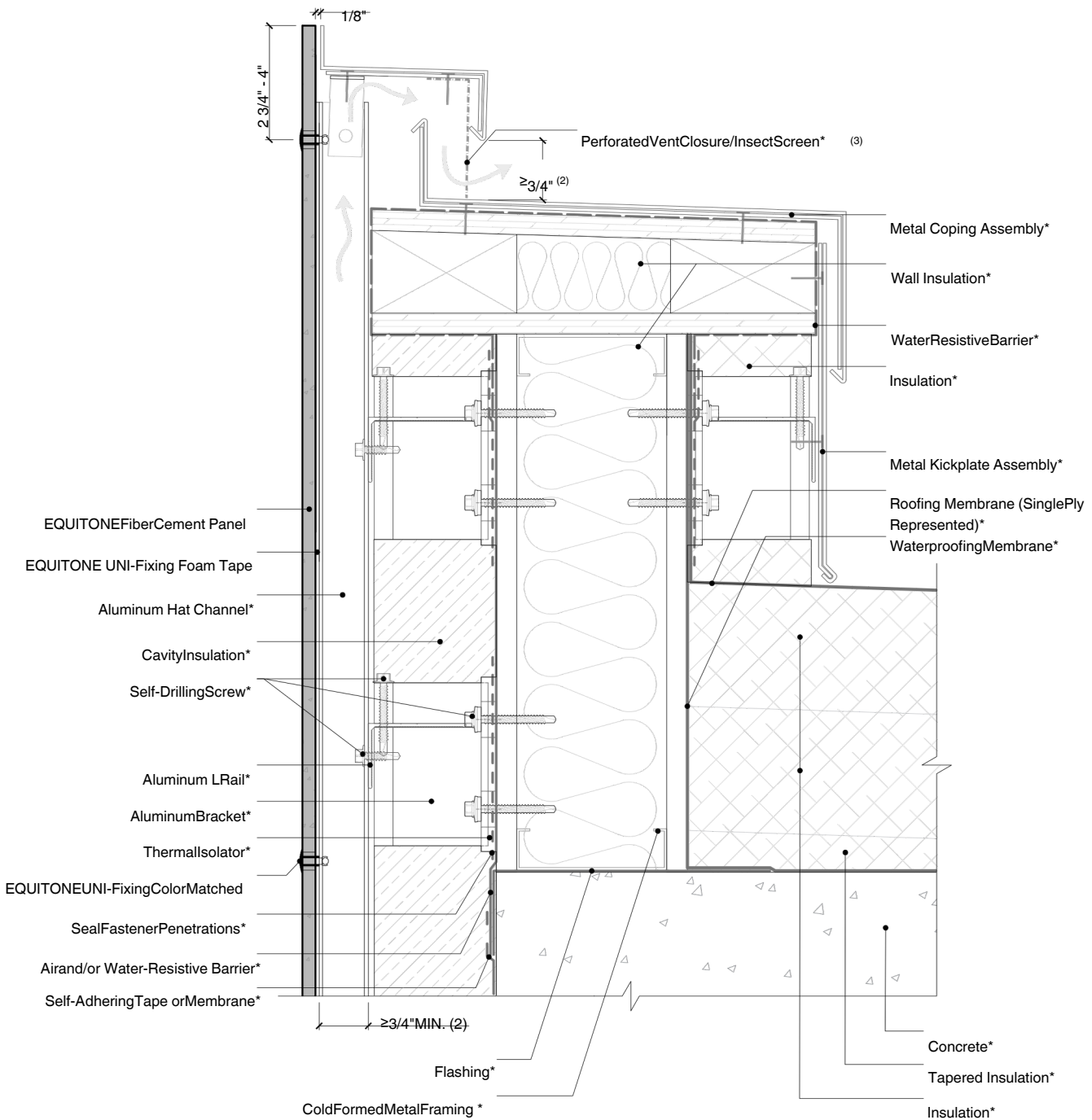

NOTES:

1. The following transition from roof to parapet is valid for parapets under 24" in height. Otherwise see detail EQ-EF-HG-SS-BFR.
2. Inlet/outlet, air cavity, and closure perforation sizing will vary, from those expressed herein, depending upon the distance between inlet/outlet or local legislation. Visit the Planning and Application Guide - Face Fixing to Metal for additional information.
3. When the inlet/outlet is wider than 3/4 inch continuous, a perforated closure is recommended to prevent debris build up. The perforation pattern should allow the same volume of air to pass through as the specified continuous open joint size specified in EQUITONE guidelines.
4. Where a perforated closure is not obstructing the inlet/outlet, the opening should be a minimum of 3/8 inch continuous.
5. (*) symbol represents materials not supplied by EQUITONE.



DETAIL #: EQ-EF-ALCR-SS-C2
RELEASE: 202412
REGION: NORTH AMERICA
WWW.EQUITONE.COM

COPING DETAIL - OPTION 2

EQUITONE EXPOSED FASTENER USING ALUMINUM CLIP AND RAIL SYSTEMS ON STEEL STUD CONSTRUCTION

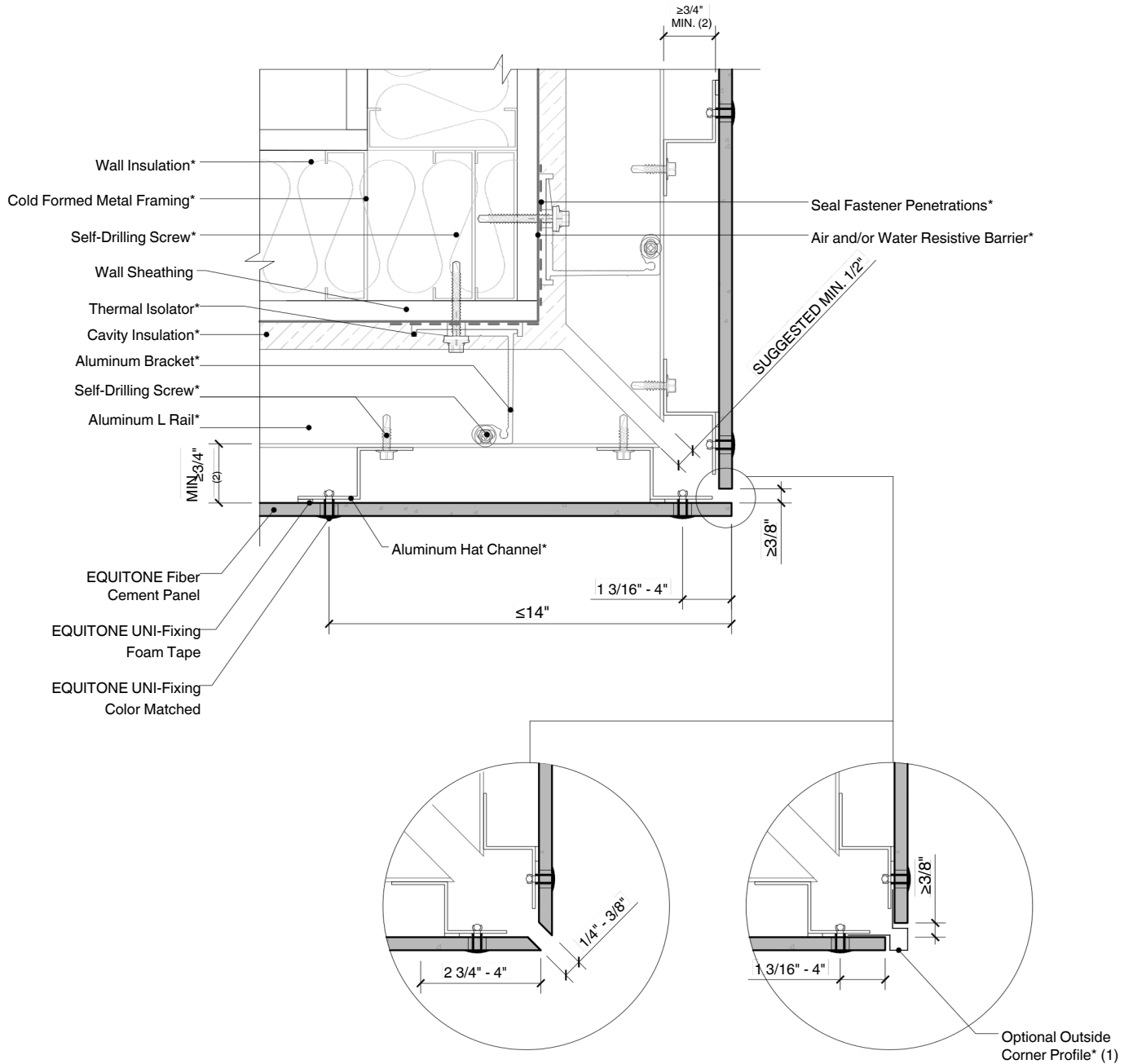

NOTES:

1. Flashing used to close the joints may not be thicker than 1/32 in (23 gauge), including the thickness of any fastener heads.
2. Inlet/outlet, air cavity, and closure perforation sizing will vary, from those expressed herein, depending upon the distance between inlet/outlet or local legislation. Visit the Planning and Application Guide - Face Fixing to Metal for additional information.
3. (*) symbol represents materials not supplied by EQUITONE.



DETAIL #:EQ-EF-ALCR-SS-OC

RELEASE:202412

REGION: NORTH AMERICA

WWW.EQUITONE.COM

**OUTSIDE CORNER
DETAIL**

EQUITONE EXPOSED FASTENER USING ALUMINUM CLIP AND RAIL SYSTEMS ON STEEL STUD CONSTRUCTION

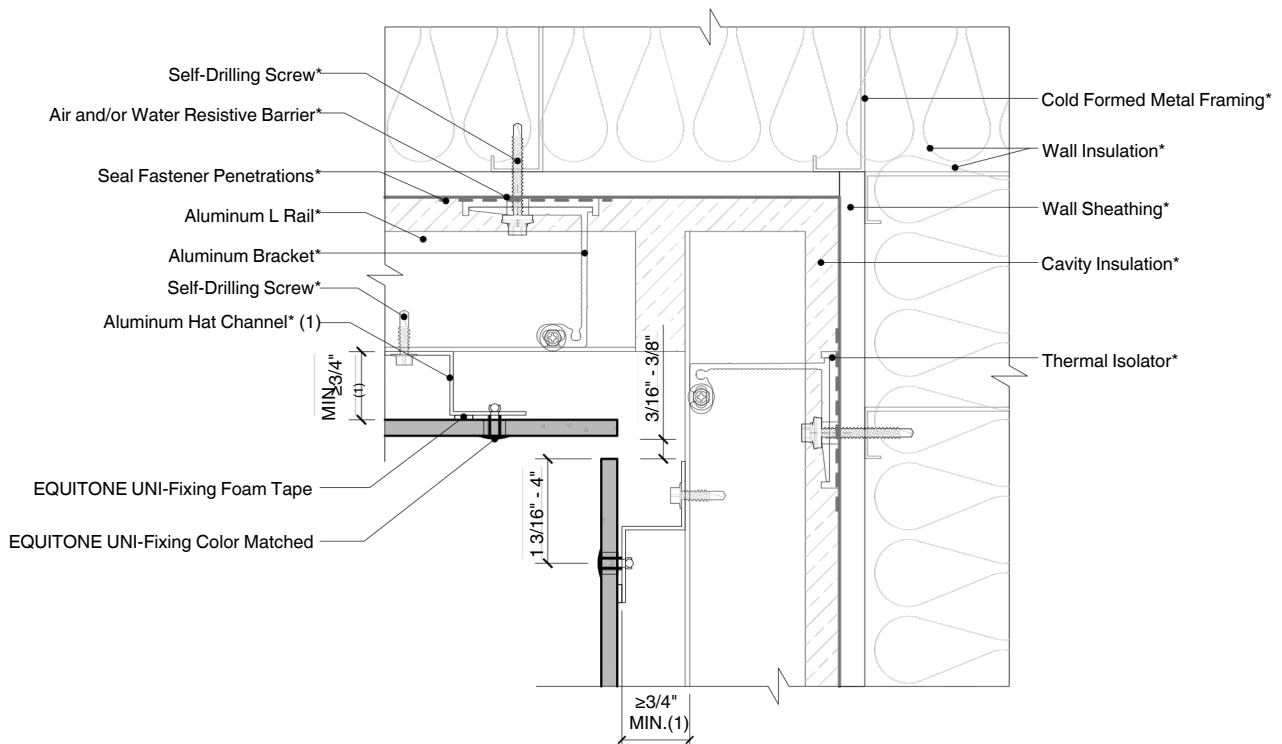

NOTES:

1. Inlet/outlet, air cavity, and closure perforation sizing will vary, from those expressed herein, depending upon the distance between inlet/outlet or local legislation. Visit the Planning and Application Guide - Face Fixing to Metal for additional information.
2. (*) symbol represents materials not supplied by EQUITONE.



DETAIL #:EQ-EF-ALCR-SS-IC
RELEASE:202412
REGION: NORTH AMERICA
WWW.EQUITONE.COM

INSIDE CORNER
DETAIL

EQUITONE EXPOSED FASTENER USING ALUMINUM CLIP AND RAIL SYSTEMS ON STEEL STUD CONSTRUCTION

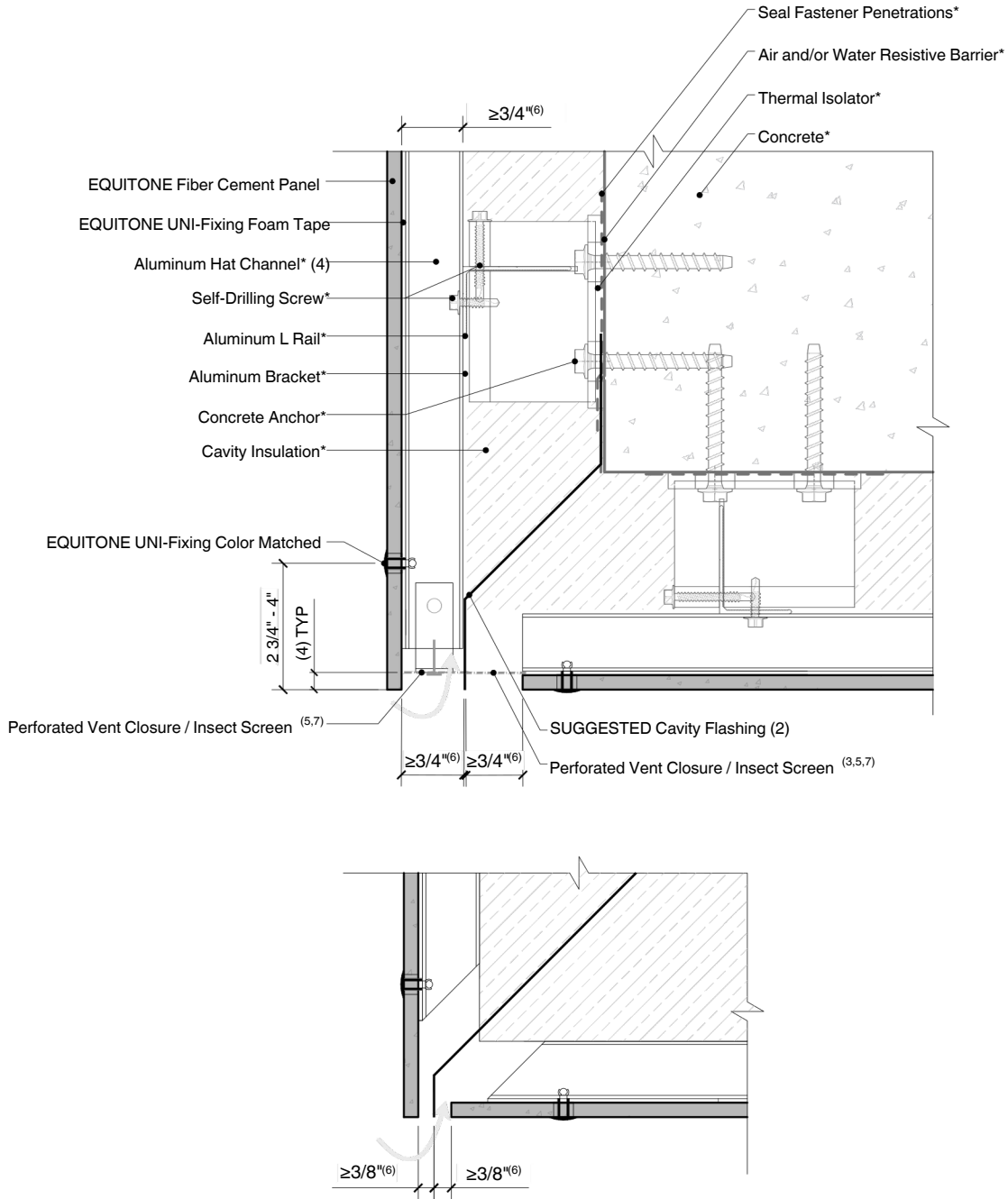

NOTES:

1. For soffit conditions, rivet spacing should be limited to 16 inch on center and should be confirmed through project engineering.
2. The following could also be detailed without a through wall flashing, but it may increase the risk of water marks and efflorescence on the face of the soffit panel material. At minimum, EQUITONE's ventilation guidelines must be followed.
3. Flashing used to close the joints may not be thicker than 1/32 inch (23 gauge), including the thickness of any fastener heads.
4. The facade panel should preferably overhang more than 3/8 inch below ventilation profile to create a drip edge.
5. All closures, trims, screens, etc. should be held off the back of the panel by at least 1/16 inch.
6. Inlet/outlet, air cavity, and closure perforation sizing will vary, from those expressed herein, depending upon the distance between inlet/outlet or local legislation. Visit the Planning and Application Guide - Face Fixing to Metal for additional information.
7. When the inlet/outlet is wider than 3/4 inch continuous, a perforated closure is recommended to prevent debris build up. The perforation pattern should allow the same volume of air to pass through as the specified continuous open joint size specified in EQUITONE guidelines.
8. Where a perforated closure is not obstructing the inlet/outlet, the opening should be a minimum of 3/8 inch continuous.
9. (*) symbol represents materials not supplied by EQUITONE.



DETAIL #:EQ-EF-ALCR-SS-SCO

RELEASE:202412

REGION: NORTH AMERICA

WWW.EQUITONE.COM

**SOFFIT / CEILING
WALL JUNCTION -
OUTSIDE EDGE**

EQUITONE EXPOSED FASTENER USING ALUMINUM CLIP AND RAIL SYSTEMS ON STEEL STUD CONSTRUCTION

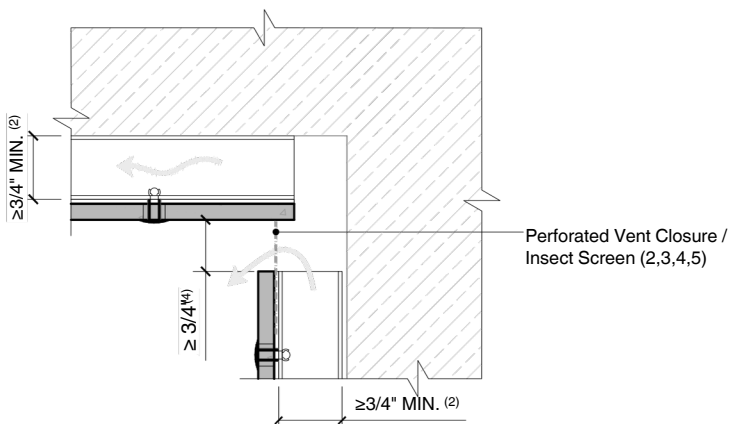
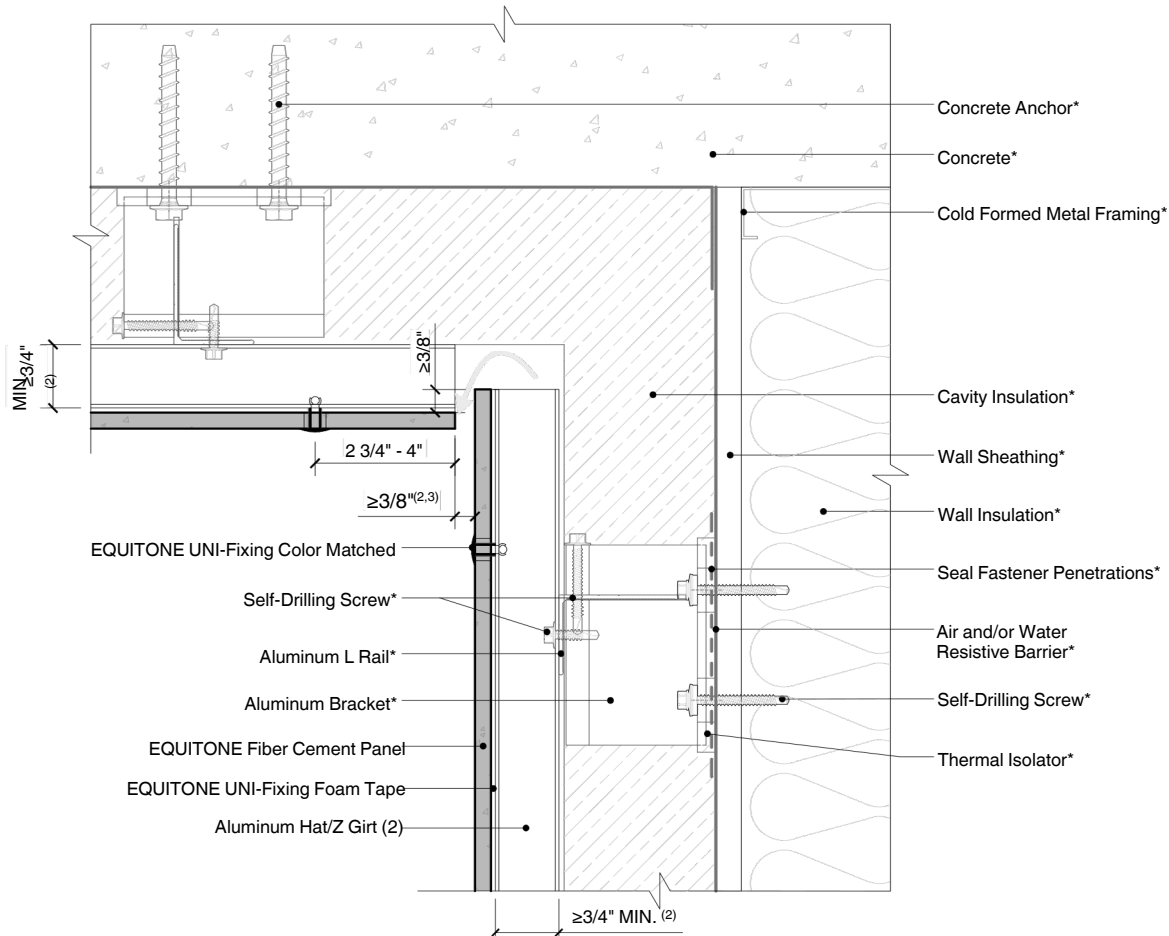

NOTES:

1. For soffit conditions, rivet spacing should be limited to 16 inch on center and should be confirmed through project engineering.
2. Flashing used to close the joints may not be thicker than 1/32 inch (23 gauge), including the thickness of any fastener heads.
3. All closures, trims, screens, etc. should be held off the back of the panel by at least 1/16 inch.
4. Inlet/outlet, air cavity, and closure perforation sizing will vary, from those expressed herein, depending upon the distance between inlet/outlet or local legislation. Visit the Planning and Application Guide - Face Fixing to Metal for additional information.
5. When the inlet/outlet is wider than 3/4 inch continuous, a perforated closure is recommended to prevent debris build up. The perforation pattern should allow the same volume of air to pass through as the specified continuous open joint size specified in EQUITONE guidelines.
6. Where a perforated closure is not obstructing the inlet/outlet, the opening should be a minimum of 3/8 inch continuous.
7. (*) symbol represents materials not supplied by EQUITONE.



DETAIL #:EQ-EF-ALCR-SS-SCI
RELEASE:202412
REGION: NORTH AMERICA
WWW.EQUITONE.COM

**SOFFIT / CEILING
WALL JUNCTION -
INSIDE EDGE**

EQUITONE EXPOSED FASTENER USING ALUMINUM CLIP AND RAIL SYSTEMS ON STEEL STUD CONSTRUCTION

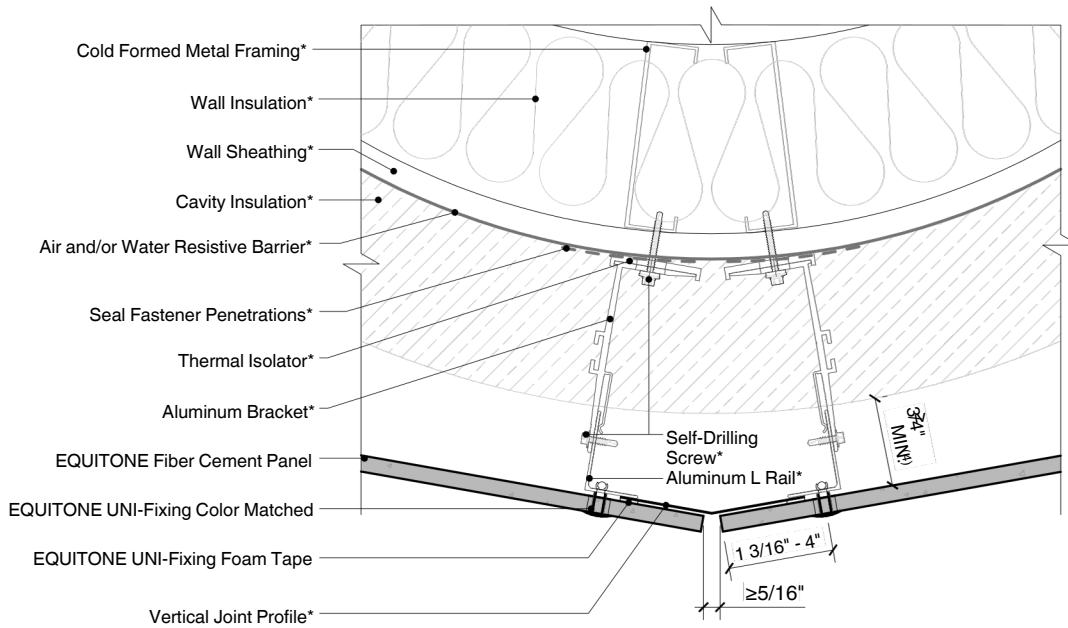

Segmented Facade - Radius < 39 Feet

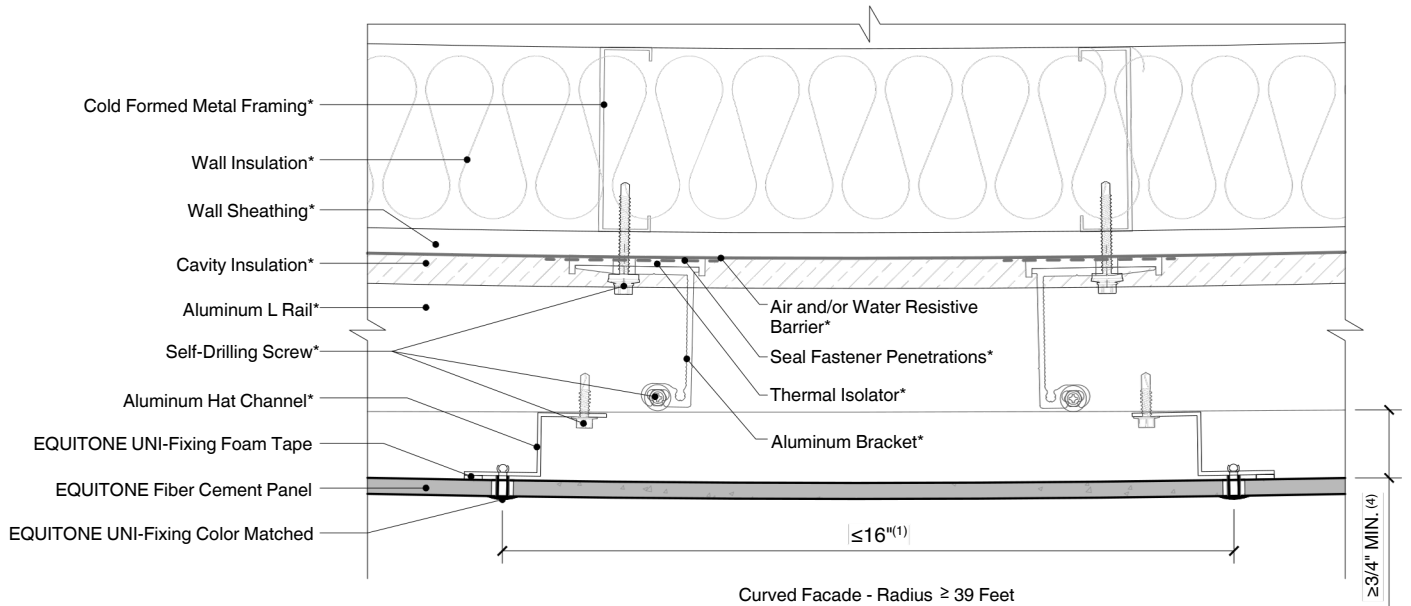

Curved Facade - Radius \geq 39 Feet

NOTES:

1. The minimum an EQUITONE panel can be curved is 39ft with framing centers reduced to a maximum of 16 inch. Confirm with subframe supplier if the intended system can achieve design radius.
2. For smaller radii the facade should be executed as segmented facade.
3. Flashing used to close the joints may not be thicker as 1/32 in (23 gauge), including the thickness of any fastener heads.
4. Inlet/Outlet, air cavity, and closure perforation sizing should be modified, from those expressed herein, depending upon building height and/or local legislation. Visit the Planning and Application Guide - Face Fixing to Metal for additional information.
5. (*) symbol represents materials not supplied by EQUITONE.



DETAIL #:EQ-EF-ALCR-SS-CURVE
RELEASE:202412
REGION: NORTH AMERICA
WWW.EQUITONE.COM

CURVED FACADE DETAILS

EQUITONE EXPOSED FASTENER USING ALUMINUM CLIP AND RAIL SYSTEMS ON STEEL STUD CONSTRUCTION

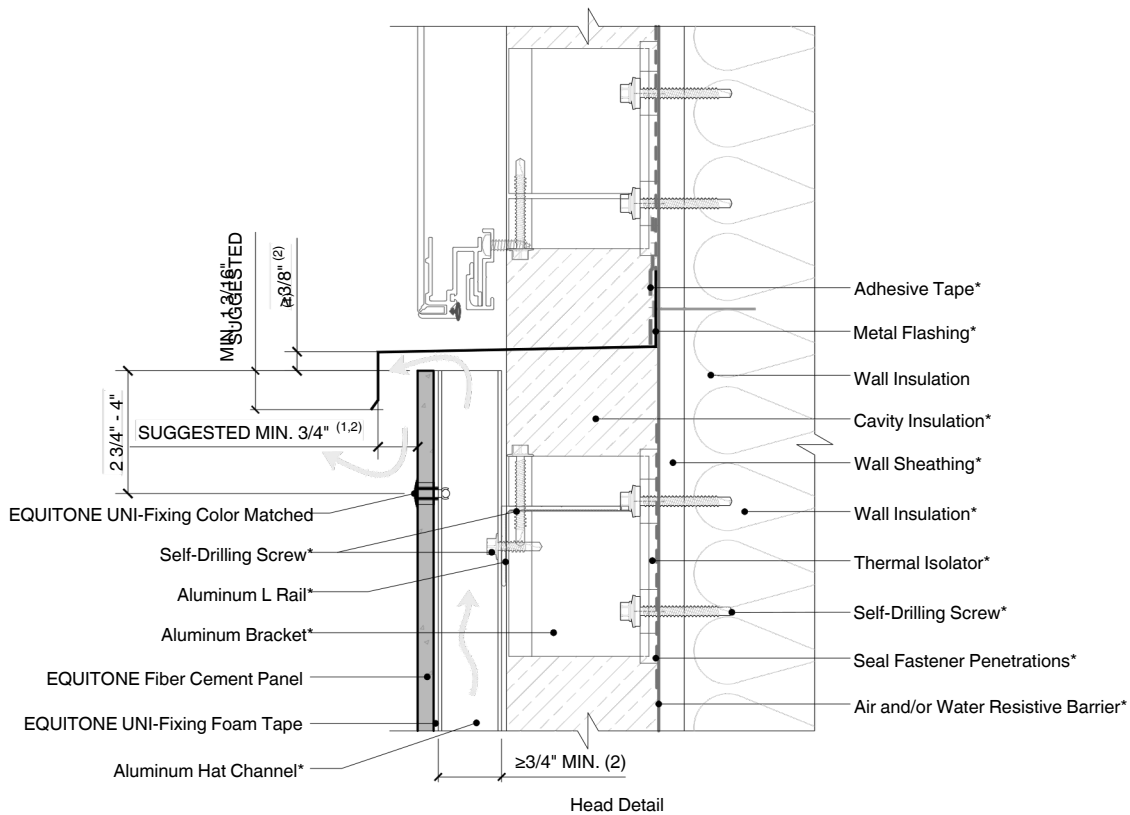
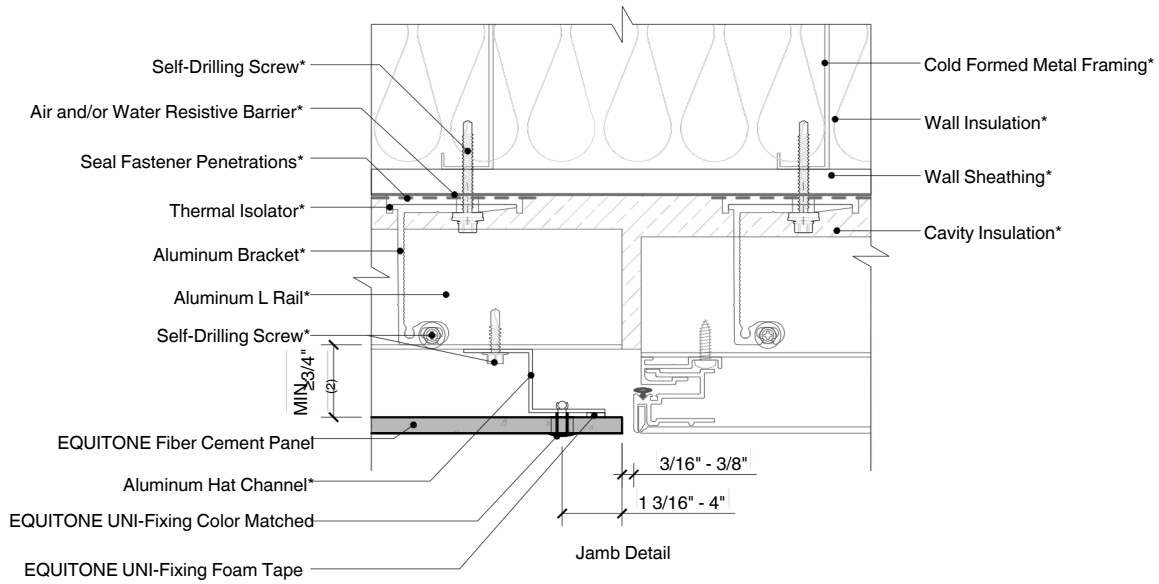

NOTES:

1. A smaller overlap is possible, but it may increase the risk of water marks and panel staining caused by runoff. Smaller capping is also more prone to wind driven rain entering the cavity.
2. A smaller overlap or offset is possible, but it may increase the risk of water marks and panel staining caused by runoff. Smaller capping is also more prone to wind driven rain entering the cavity. At minimum, EQUITONE's ventilation guidelines must be followed.
3. Inlet/Outlet, air cavity, and closure perforation sizing should be modified, from those expressed herein, depending upon building height and/or local legislation. Visit the Planning and Application Guide - Face Fixing to Metal for additional information.
4. (*) symbol represents materials not supplied by EQUITONE.



DETAIL #:EQ-EF-ALCR-SS-OM

RELEASE:202412

REGION: NORTH AMERICA

WWW.EQUITONE.COM

JUNCTION WITH
OTHER FACADE
MATERIAL DETAILS

EQUITONE EXPOSED FASTENER USING ALUMINUM CLIP AND RAIL SYSTEMS ON STEEL STUD CONSTRUCTION

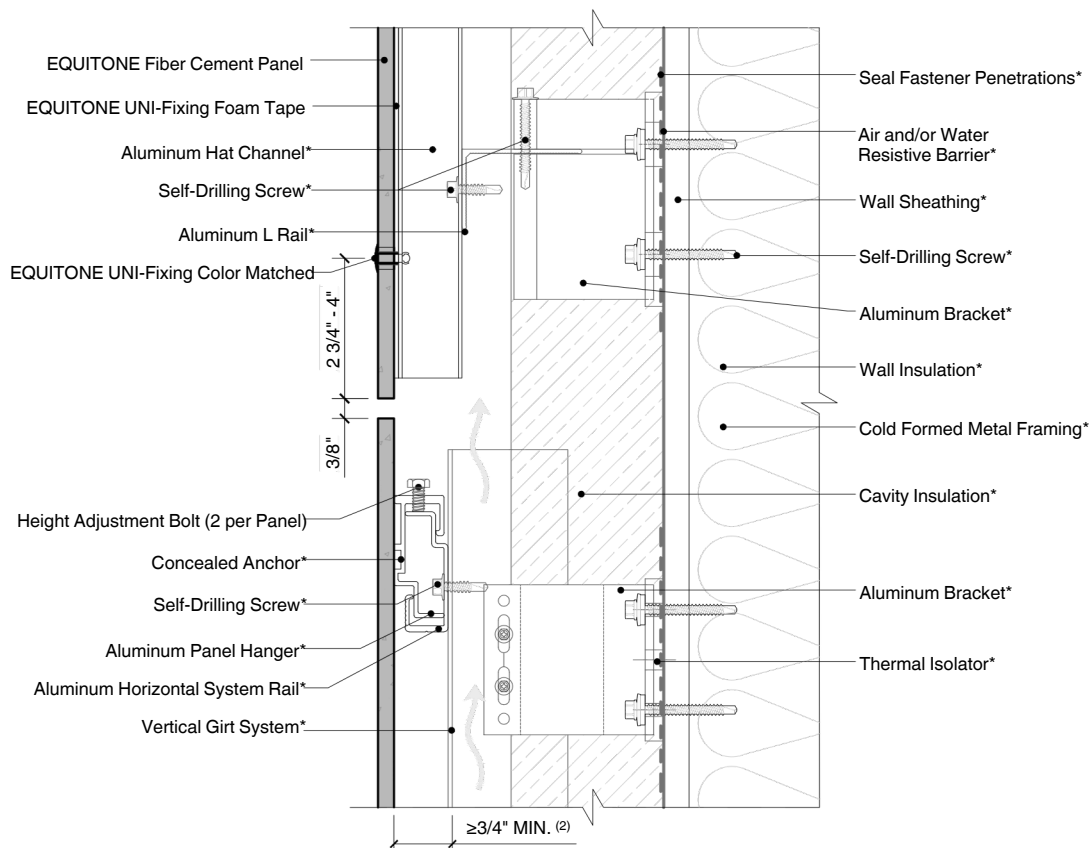

NOTES:

1. The ventilation path must be maintained between varying systems to allow clear vertical air flow.
2. Inlet/outlet, air cavity, and closure perforation sizing will vary, from those expressed herein, depending upon the distance between inlet/outlet or local legislation. Visit the Planning and Application Guide - Face Fixing to Metal for additional information.
3. (*) symbol represents materials not supplied by EQUITONE.



DETAIL #:EQ-EF-ALCR-SS-FJ
RELEASE:202412
REGION: NORTH AMERICA
WWW.EQUITONE.COM

**EXPOSED FASTENER -
CONCEALED FASTENER
JUNCTION**

General Information

This document provides generic construction details for EQUITONE façade systems with exposed fasteners to assist with the design of the EQUITONE façade.

This document is not designed to serve as an installation guide and is intended to be used in conjunction with the relevant EQUITONE Planning and Application Guide and other technical and installation documents.

The details included in this document only illustrate general principles for detailing EQUITONE at different typical interfaces and are not to be relied upon for weatherproofing and fire safety compliance with local regulations. The weatherproofing and fire performance of any project-specific detail or application shall be evaluated by the project engineer or consultant.

Any components related to wind barriers, fire safety, moisture management, and weatherproofing include but are not limited to membranes, flashing, water seals and sealants, airtightness tapes, horizontal and/or vertical fire barriers, etc. will need to be applied according to local regulations, project requirements, and relevant standards.

The support frame, fixings, flashings, and the like shall be of adequate corrosion resistance appropriate to the corrosivity category of the project location.

All dimensions in this document are in inches [in] unless otherwise stated.

The information in this guide is comprehensive but not exhaustive, and the reader will need to satisfy themselves that the contents of this guide are suitable for their intended application. It is the responsibility of the project consultants (designers, architects, and engineers) to ensure that the information and details provided in this document are appropriate for the project.

The information in this document is correct at the time of issuing. However, due to our committed program of continuous material and system development, we reserve the right to amend or alter the information contained in this document without prior notice. Please visit www.equitone.com to ensure you have the most current version.

This document is supplied in good faith and no liability can be accepted for any of or damage resulting from its use. Images and construction details contained in this document are not to a specific scale, are indicative and for illustration purposes only, and should not be used as final construction drawings.

This document is protected by international copyright laws. Reproduction and distribution in whole or in part without prior written permission is strictly prohibited. EQUITONE and logos are trademarks of Etex NV or an affiliate thereof. Any use without authorization is strictly prohibited and may violate trademark laws.



Please visit www.equitone.com for contact details further information and technical documents.



www.equitone.com

USA/Canada 1731 Fred Lawson Dr.
Maryville TN, 37801 Tel: +1 865 268 0654
E-mail: info.usa@equitone.com
www.equitone.com/en-us/
www.equitone.com/en-ca/